

The PLAY EQUIPMENT catalogue



www.husson.eu



PLAYING, RUNNING, ...WINNING!

Going outside, running around, and playing with others, living **dreams**. All benefits that children can obtain from open-air playgrounds.

But, playgrounds are not just a place for playing; in fact, increasingly often they are becoming places to live and **interact for all**.

Playing outside is also a real **springboard towards sport**, sportsmanship, and, why not, even to winning medals.

This is why we encourage decision-takers to recognize the importance of playgrounds for improving everybody's environment.

With our new PLAY EQUIPMENT catalogue and its share of dreams and magic, but with the whole HUSSON team as well, the time has come to share our know-how and experience with you. We offer you all our help in creating your future leisure areas together, so that they are even more aesthetic, more attractive and safer.

Your HUSSON regional manager, experienced in all the issues related to public leisure areas is available for giving you advice, from preliminary studies right through to installing your custom-built playground.

And now ... it's your turn to play!

Yours,

Daniel Husson
President and CEO



Our new catalogue has been developed as a work tool for designers and **decision makers** with:

- A practical summary for viewing all the different ranges for each category at a glance.
- A link to our web site using a **key-code**.
- A **back cover flap** that is always available for explaining the coherence of themes and associated colour matches.
- To complete your project, **2 extra brochures: COLOR'ADO multisports and URBAN FURNITURE.**

Pages

CONTENTS

24



PICCOLO
2-5 years

58

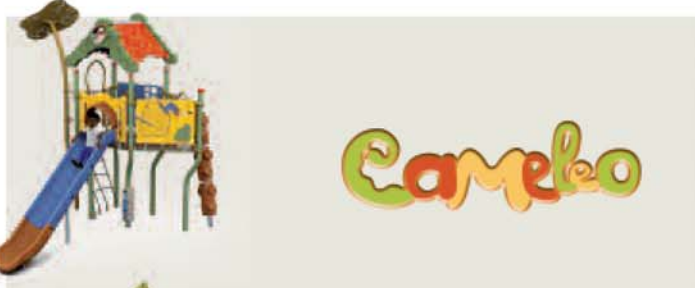

CAMELEO
4-10 years

108



CAMELEO XL
4-12 years

116



VERTIGO
7-14 years

136



MAGIC'COLOR
2-8 years

164



SOLO +

Why have playgrounds?

► For helping children to develop

All studies have reached the same conclusion on the importance of playgrounds.

PLAYING is a vital function for children: Playing enables them to develop on different levels: physical, mental, sensorial, emotional and social.

PLAYING to discover

Children, especially the younger ones, are curious about everything. They need to explore and discover their environment. This is why playgrounds must create a sense of magic and excitement to draw children in of all ages and ability.

PLAYING for fun

Children love and need to go outside to play, run around, shout, laugh and do everything else that children do to help release the energy that is bursting to get out... So, playgrounds must offer lots of things to do.

With a large number of action games, clambering, climbing, obstacle courses, sliding, etc. Husson multi-play units create a sense of magic that is full of exciting challenges.

PLAYING for health

A large number of studies reach the same conclusion on the worrying problem of overweight children and adolescents, a risk factor for obesity in adulthood. Physical activity in open-air playgrounds is an efficient solution approved by child specialists in every domain.

PLAYING for imagining

Children, especially 3 to 6-year olds, adore imaginary worlds of fantasy.

They love playing at pretending!

This is why HUSSON has developed imaginary worlds with giant flowers (the Fantastic theme), forests (the Forestic theme) and quirky-shaped houses (the Cartoon theme).

HUSSON also proposes magnificent role-playing concepts where our adventure and magic-loving children love to transform themselves into princes or princesses, pilots or pirates.

PLAYING for sharing

Husson proposes a large number of fun activities that encourage children to play together and, in this way, enrich their first experiences of life in society.

PLAYING for growing up

"You have to **PLAY** to become serious". (Aristotle)

► For improving the living environment of all generations

Playgrounds are not just recreation areas, but increasingly often, meeting points where social interaction can take place between all generations. We sometimes forget just how much parents, child minders and grandparents need this!

Many parents regularly point out that they have most of their contact with other parents in "recreation grounds" that they like going there and, why not, they actually like using the play equipment themselves!

► For safety

Contrary to what you may think, the installation of playgrounds in any given environment does not increase the overall number of accidents but rather reduces them. Data from recent studies* clearly shows that building playgrounds in schoolyards reduces the number of accidents by up to 75%.

Husson provides playground equipment that is amongst the safest in the world.

* Source: FIFAS/APEAJ





PLAY from 1 to 99 years old!

Husson will propose the right product range based on the age and ability of the user.

“Nursery school” structures for 2 to 5 year olds.

PICCOLO modular play structures are specially designed for little children from 2 to 5 years old, at “nursery school” age. Certain configurations are even suited to 1-year old toddlers.

Platforms are between 40 and 120 cm high and equipped with easy-to-use means of access to make them easy to reach and to teach children how to get a better sense of their position in space.

Several vehicles in the **MAGIC’COLOR** range are suitable for 2 to 5-year olds.

Lastly, many individual games in the **SOLO** range have been especially designed for small children and are perfect for completing a play scheme.

“Primary school” structures for 5 to 10 year olds.

CAMELEO modular play structures are designed for children from 4 to 10 years old.

Several vehicles in the **MAGIC’COLOR** range are suited to this age group, as well as a large number of individual items in the **SOLO +** range.

The “seniors” from 6 to 12 years old.

VERTIGO modular multi-play units (MPU’s) are designed for “seniors” from 7 to 14 years old.

The large towers in the **CAMELEO XL** range are perfectly suitable for children from the age of 4 upwards.

Lastly, a large number of individual play items in the **SOLO+** range have been designed for inclusion into a modular structure.

Pre-adolescents and teenagers from 12 to 17 years old.

VERTIGO MPU’s are also designed for pre-adolescents (10-13 year olds).

Many individual play items in the **SOLO+** range have been designed for completing a Vertigo structure. Lastly, the entire, ever-popular **COLOR’ADO** multisport programme is devoted to them: please refer to the specific **COLOR’ADO** brochure.

Adults

Adults have not been forgotten, certain items of equipment have also been designed specifically for them:

- **COLOR’ADO** multisports: Please refer to the specific **COLOR’ADO** brochure.
- Fitness equipment and exercise courses
- Table-tennis and table-football tables (**SOLO+** range)
- Furniture (benches, tables, picnic tables, etc.): Please refer to the specific **STREET FURNITURE** brochure.





Play equipment for ALL

Because children need to play, playgrounds should encourage and enable children of all abilities to play together.

One only has to witness the joy on the faces of children playing together in any given playground to see that inclusive play provides the best chance of a stimulating, engaging and happy environment for everybody.

This explains why, as early as in 1993, HUSSON began working with specialized centres and town councils in an effort to make play grounds accessible to all children.

Concrete results: Working together in this way gave rise to novel practical solutions, such as:

- Accesses to playgrounds and equipment made easier by working on the different levels of ground and/or with gently sloping inclines.
- Easily accessible, original, play equipment on ground level such as the new Roadster or Jeep concepts...
- **Our new DUNE** concept inviting all children to play together. This enables children with a disability to progress alone or with assistance. This new activity also offers more seriously disabled children the possibility of accessing upper levels of play structures and discovering all the joys of going down a slide. This has been made possible by long-term work with teaching specialists, physiotherapists and doctors... who have taught us a great deal, especially in the field of ergonomics. They also showed that sometimes they knew how to "lend their bodies" to children to help them progress. For every child every bit of progress, however small, is precious. Every step forward makes them become more independent and gives them more confidence in themselves.

If the playground is planned to be installed in a specialist centre for children with identifiable disabilities, it needs to be studied in close cooperation with medical staff.

In public areas, we must aim at having playgrounds accessible to the widest possible range of children. This is why we propose the following approach, which consists of:

- 1) Consulting parents of disabled children living in the neighbourhood and/or specialist associations as early as possible,
- 2) Contacting the HUSSON representative who can make his experience available, and, with the help of our Design department, analyse the overall project together with you.
- 3) Looking for the best possible solutions for equipping playgrounds successfully and making them as accessible as possible for children of all abilities.
- 4) Choosing play equipment in the catalogue that is already accessible to all **1** or equipment that can be easily adapted **2**
- 5) Having 3D CAD plans of the proposed solutions drawn up by the HUSSON design office, free-of-charge and without any obligation, together with a quotation.

1  Play equipment accessible to ALL

2  Play equipment easily adaptable for disabled children





Arrival in a wheelchair



1



2

Transfer



Concept

5

1

2

3'

3'

3

4

3



5

Recovery in the wheelchair



Making it to the top together



Sliding



4









10 Suggestions for creating a successful playground

1- Beforehand:

- Choose a suitable location
- Consult future users
- Allocate an overall budget (equipment, installation costs, safety surfacing, furniture, linking paths, landscaping, consulting and miscellaneous items, etc.)

2- Contact your exclusive HUSSON representative

A professional, close to his clientele, will help and advise you from the analysis of the initial project through to its completion.

3- A playground for all:

- Plan for play areas suited to the normal age groups (small, medium and teenagers) and the corresponding ranges of play equipment (PICCOLO, CAMELEO, VERTIGO, etc.).
- Do not forget the adults and remember to create easy access for wheelchairs.

4- Durable play equipment:

- Plan for the toughest materials in sensitive and/or high-use zones.



5- A playground that goes well with its environment:

- Plan the themes and their corresponding colour matches.
- Choose the same theme for all the different play areas or, on the contrary, differentiate them all.

• For example, the above project with:

- 1 A zone for small children (1-5 years old):
PICCOLO play equipment from the "Cartoon" theme
- 2 A zone for medium children (4-10 year olds):
CAMELEO play equipment from the "Forensic" theme
- 3 A zone for older children (7-14 year olds):
VERTIGO play equipment from the "Urban 1" theme
- 4 A teenagers' zone: multisports from the "Park" theme.

6- A really "fun", attractive playground:

- Plan a play structure (**PICCOLO, CAMELEO, VERTIGO...**) or each zone and, if needs be, modify it by adding some of the 200 different activities/elements available.
- Complete the play structure with individual items from the **SOLO** range (spring play equipment, roundabouts, rope games, etc.) and **MAGIC'COLOR**.

7- A friendly, sociable area:

- Plan for hospitable seating, flower planters and litterbins.

8- A successful set-up:

- If considerable landscaping, site works and miscellaneous items are required, call on a specialist (landscape architects, etc.)
- Provide access paths and links between the different zones, fencing, trees and vegetation...

9- A complete project proposal free-of-charge

Supplied by the HUSSON design office with 3D visualizations and site plans along with a detailed quotation.

10- Drawing up a general schedule:

Design brief, advice, analyses, consultations, choices, manufacturing, installation, event management and opening day!

HUSSON, since 1920!

► A model company

A few important dates

1920: The beginnings of the company. Emile HUSSON, a blacksmith in Orbey (Alsace) is the specialist in quality ... ironwork!

1950: His son Roland HUSSON successfully develops and industrializes this "ironwork know-how" in steel construction systems.

1988: The company diversifies towards play and sports equipment under the leadership of Daniel HUSSON, the blacksmith's grandson and a sportsman through and through.

2012: The HUSSON group becomes a world leader in play and sports equipment with 105 highly qualified members of staff available to help over 26,000 faithful clients present on all five continents.

A responsible company:

Since its beginnings, HUSSON has remained a family "man-sized" company.

Husson is a family Group not quoted on the market. The strategy is put on a long term outlook for customers employees and partner's loyability.

► 6 principles and an ethic

Sportsmanship: Encouraging sports activities and, above all, sportsmanship.

Quality and long-life:

The customer is our boss!

Safety: It is the starting point of everything we do.

Design and innovation:

Beauty lies in simplicity of design

Efficiency: Being good is not enough, you have to be better.

Environment: For today, tomorrow and for many years to come.

● Sportsmanship

At HUSSON, we like sport. It is our motto, our passion and our motivation.

● Quality

HUSSON quality is a continuous improvement approach with:

- The expertise of its engineers, technicians, work-force and representatives
- Control over the complete process: Design – procurement – manufacture – installation – after-sales service
- The choice of the best materials and surface treatment.

● Safety

Husson designs and builds its equipment to provide exceptional levels of safety to its clientele and users.

● Design & innovation

Integrated Design and R&D departments possessing a team of engineers, designers and technicians who tirelessly develop new product lines as well as their own, ingenious systems validated by a large number of patents and models.

● Efficiency

An industrial force

Production is concentrated at two plants based in the Alsace in the heart of Europe with a total covered surface of over 21,000 m².

Due to its constant investment policy, HUSSON possesses ultramodern industrial tooling, unmatched in its field.

The HUSSON group has recently invested in:

- A new fully automated, robotized powder coating line.
- A brand new plant equipped with the very latest rotation moulding machines.
- New premises for Husson UK in London with showroom and warehousing.

Global expertise at the customer's service:

Husson provides comprehensive assistance to its customers and their architects in every project:

Site survey: Made by a HUSSON representative, experienced in the many potential issues of public spaces and who will assist customers from the analysis of the initial project through to its completion.

Studies: 3-D CAD visualization and 2D site plans produced by the HUSSON design office.

"Turn-key installations": By HUSSON's own assembly teams or using a HUSSON approved professional installer.

Long-term after-sales service and guarantees:

by HUSSON Services, a specialist subsidiary of the HUSSON Group.





● Environment

Nestling in a magnificent setting at the foot of the Vosges Mountains, HUSSON has always been very sensitive to environmental protection.

This is a real company project for all the staff and it contains firm commitments:

- ❶ Exemplary production units with really low air and water discharge ratios.
- ❷ Reduced CO2 emissions, notably due to the concentration of HUSSON's activities in the centre of Europe, which limits transport to a minimum.
- ❸ Use of non-aggressive, ecologically inert materials that are easy to recycle at the end of their service life, as is the case for steel.
- ❹ Application of surface treatment that protects the environment and the health of users.
- ❺ Design of products generally planned to last for 30 years or more, as this also means SUSTAINABLE development!



HUSSON : Toughness par excellence!

Toughness and safety are deep-rooted in HUSSON designers' culture:

with all their years of experience, they are well aware that, for public playground equipment, one does not go without the other.

▶ Legendary toughness

HUSSON playground equipment has a well-earned reputation for:

- Its exceptionally long service life, often more than 30 years
- Remarkably easy and highly economical maintenance
- With, as a result, a highly competitive overall cost.

▶ Quality in the smallest detail

The quality of HUSSON play equipment has a well-deserved international reputation.

First-class materials and surface treatment:

• **For structural elements**, steel, or even stainless steel, is generally chosen for its high level of resistance in the face of intensive use ...

Steel components receive double surface treatment of exceptional quality:

Treatment n° 1: Hot-dip galvanising after fabrication (both inside and outside tubes).

Treatment n° 2: Powder coating (oven-baked polyester powder paint).

This double coating is highly resistant to the severest climates and to acts of vandalism.

• **For the panels**, Husson mainly uses HPL (high-pressure laminate): really tough and resistant, low-flammability, colour-through material requiring very little maintenance.

• **For complex forms**, HUSSON uses HDPE (High Density Polyethylene), or equivalent, thermoplastic rotation moulding technology. These elements are produced by Dtplast, a subsidiary of the HUSSON group.

• **Design and production of our own exclusive systems*** such as our cast-aluminium multidirectional assembly collars or our special stainless steel vandal-proof fasteners (impossible to undo without the Husson proprietary tool).

* Patented systems

▶ 10-year guarantee

The PICCOLO, CAMELEO, VERTIGO and MAGIC'COLOR ranges are guaranteed by HUSSON for 10 years:

Parts guaranteed: Metal structures (framework and assembly parts) HPL panels and flooring.

Conditions of application for HUSSON guarantees: please refer to HUSSON's general conditions of sale (on the back pages of the price list in force).

▶ Maximum safety

With over 30 years' experience in designing, building, installing and servicing playgrounds, HUSSON builds and tests its ranges so that children can play in an exceptionally safe environment.

HUSSON play equipment is designed to meet the new European EN 1176 standards, version 2008.

Compliance with standards is guaranteed by controls and certificates issued by an independent control laboratory. (**Prélud , TÜV or Pourquery**).

Pushing concern for safety to the highest possible levels, HUSSON play equipment is ahead of standards in force on a large number of points. This is the case for:

- The solidity of structural work and flooring
- Protective barriers for fall-prevention

Prélud



LP LABORATOIRES POURQUERY









HUSSON : Considerable international experience

Husson is a major player in the design and manufacture of play equipment and sports areas. Its representatives offer global expertise to assist its customers: local authorities, leisure parks and outdoor accommodation entities, etc.

► The experience of local authorities



Munich / ALLEMAGNE



Seoul / COREE



Montpellier / FRANCE



Asnières / SUISSE



Montreal / CANADA



Strasbourg / FRANCE



Balexert / SUISSE



Lancon de Provence / FRANCE



Caen / FRANCE



Namur / BELGIQUE



Lyon / FRANCE



London / UK



Vienna / AUTRICHE



London / UK



► The experience of leisure parks, outdoor accommodation, shopping centres, etc.



La Vallée Village / Disneyland Paris



La Vallée Village / Disneyland Paris



Marineyland Antibes



Campéole



Kawan



Camping "Bleu marine"



La Mer des Sables / Compagnie des Alpes



Postel /Belgique



Bioscope /Compagnie des Alpes



Mc Donald's Europe/ Outdoor Ronald Gym Club



Aérodrome Eolys



Futuroscope Leisure Park



Décathlon



Shopping Centre Mc Arthur /Troyes



Hippodrome of Vincennes

HUSSON : A passion for innovation

Possessing a very considerable amount of experience, the HUSSON team of engineers, designers and technicians proposes original, novel concepts such as:

1989: Husson is the First European Company to propose all-metal play equipment when the trend is clearly towards all-wood. Since that time, practically all its competitors have followed in Husson's footsteps towards ...metal. Photo below: Costocolor play equipment installed in the Jardin du Luxembourg (PARIS) in 1991 and still in excellent condition after more than 20 years' intensive use!

1991: HUSSON is one of the very first companies in the world to develop play equipment targeted towards teenagers with its famous Color'ado multisport equipment.

2000: New Piccolo play equipment

2002: New Magic' color vehicle play equipment

2003: New Telerallye play equipment for leisure parks

2005: New Cameleo theme-adjustable play equipment

2007: New Outdoor Ronald Gym club play equipment exclusively for Mc Donald's Europe

2008: HUSSON launches its new covered multisport units with an exclusive concept enabling multisport pitches to be used every single day of the year!

2009: New Skate Training play equipment

2012: New collections and new HUSSON play equipment catalogue.



2005



2007

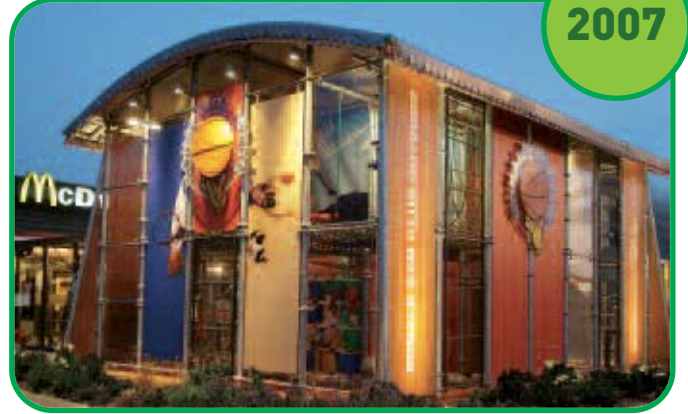

2008



2009



2012

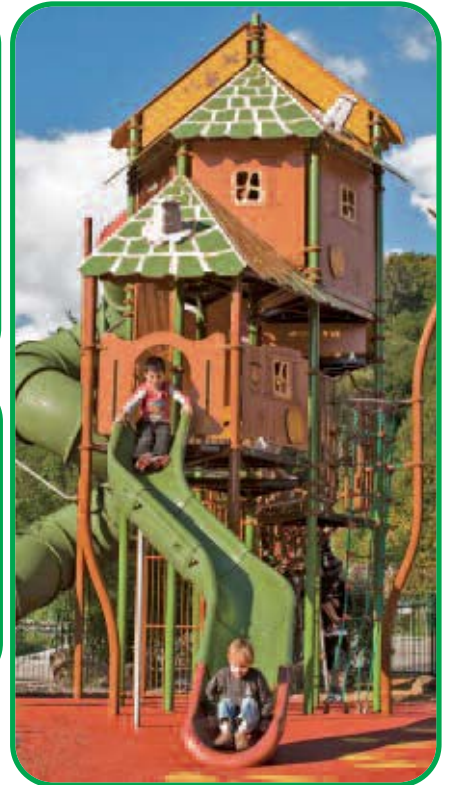

Piccolo

is magical!

The land of young adventurers!

+ Ideas

Play equipment specially designed for **2 to 5 year-olds** at **nursery school level**. Certain **PICCOLO** configurations are even suited to 1-year old toddlers.

+ Design

PICCOLO is proposed in 3 different themes: "Fantastic", "Forestic" and "Cartoon" for stimulating youngsters' imagination.

In these 3 versions, posts that are normally vertical turn into curves and become part of a dream world. Toddlers transform this larger than life, magical environment into a world full of fantasy and laughter!

+ fun

Over 120 activities for growing up by playing:

- **Early learning and interaction** with, for example: **The new driver's cab with its "moving landscape"**. The child turns the wheel and the landscape is displayed on the windscreen. And then suddenly ... bang! There's an accident. Laughter guaranteed!
- **Primary motor activities:** Made for clambering, climbing, sliding and crawling, the **PICCOLO** range becomes as one with children, and helps them to discover their body by coordinating their movements.
New: Crossing the cliffs, close to the ground and controlled by accompanying adults, they are a source of excitement for younger children and gives them their first initiation to climbing.
New: S-bend slides have the wind in their sails little bends, big thrills.
- **Meeting and sharing:** The youngsters get together, invent role-playing scenarios and in this way live their first experiences of life in society.



In a small space, a whole range of fun activities for **DISCOVERING, LEARNING** and **PLAYING**

PICCOLO
2-5 years



Piccolo



decorated in one of 3 possible themes:

PICCOLO
2-5 years



Forestic

Pages 30 to 39



Fantastic

Pages 40 to 49



Cartoon

Pages 50 to 57



The Technical +

1 - Carefully designed ergonomics:

- Platforms are between 40 to 120 cm high and 85 cm wide and are equipped with various forms of easy-to-use access to help children develop their special awareness.
- Piccolo structures include new activities for encouraging parents to participate actively in their child's progression. For example, the shapes and dimensions of platform safety barriers make it easy for adults to help guide children from ground level.

2- Even more safety:

- **PICCOLO** play equipment is designed to meet the new European EN 1176 standards, version 2008.
- Compliance with standards is guaranteed by internal quality management systems and certification issued by an independent control laboratory (Prélud, TUV or Pourquetry).
- Pushing concern for safety to the highest possible levels, **PICCOLO** play equipment often far exceeds the minimum requirements of standards and regulations in force, especially concerning the integral strength of the main structure...

3- A highly modular system

- With over 120 different component elements for creating made-to-measure play equipment, the installation can be extended in stages, allowing the playground to grow and evolve over time.

4- An assembly system* using multi-D+ clamps:

- Made in die cast aluminium
- Elegant design: Up to four components can be fitted to the same multidirectional collar
- Rounded shapes for even greater safety
- Extremely robust thanks to its double bolt fixing system

5- Toughness designed in HUSSON:

- **PICCOLO** play equipment is as tough as it is aesthetic with a galvanized steel framework designed to last for 30 years!

6- Top-quality materials:

- An extremely robust steel structure far exceeding the minimum requirements of standards in force.
- Many elements manufactured in stainless steel as the standard option.
- Panels in multicoloured HPL specially designed for HUSSON: Solid high-pressure laminate, highly resistant (15 mm thick), rot-resistant, with low-flammability levels and colour-through material.

- Components are moulded in extra-thick HDPE (High Density Polyethylene) for maximum toughness. This material is colour-through and requires minimal maintenance.
- A wide range of slides in steel/stainless steel or HPL/stainless steel or moulded HDPE.
- New netting strands with steel cores covered with a thick coat of 3-color polyamide (exclusive to HUSSON).
- Special "one tool fits all", vandal proof fasteners (exclusive to HUSSON for maximum vandal resistance).

7- Exceptional surface finish for steel elements:

- Treatment n° 1: hot-dip galvanizing after fabrication (all surfaces, both inside and outside tubes).
- Treatment n° 2: powder coating (oven-baked polyester powder paint).

This double surface treatment is highly resistant in the harshest conditions as well as to individual acts of vandalism.

8- A 10-year guarantee:

- Parts covered by guarantee: Metal framework (uprights and assembly parts) HPL panels and flooring.
- For the terms and conditions of HUSSON guarantees: please refer to HUSSON's general conditions of sale (on the back pages of the current price list).

9- Minimal maintenance:

- Use of stainless steel and galvanized mild steel as well as the unique multi-D+ assembly system* (common across all the HUSSON ranges) is the solution for a minimal, low cost maintenance routine ensuring that your play equipment is safe to use for many years to come.

10- Encouraging sustainable development:

- The equipment's shapes, themes, colours and integral structural openness make it easy to integrate **PICCOLO** play equipment harmoniously into almost any environment.
- All materials and surface coatings are ecologically inert, i.e. they remain environment-friendly throughout their service life and can then be easily recycled, as is the case for steel.
- HUSSON play equipment is renowned for its long life, another crucial aspect of sustainable development!

* Patented system



PICCOLO
2-5 years



Piccolo presented in
the theme
Forensic



PICCOLO
2-5 years



Piccolo presented in
the theme
Forensic



JPX-0001
with roof



JPX-0002
roofless



	JPX-0001	JPX-0002
Designation	Piccolo I Forensic	Piccolo I Forensic
Age group	2-5 years	2-5 years
Dimensions of equipment	(LxWxH in mm) 2461 x 1291 x 3000	(LxWxH in mm) 2443 x 1195 x 1816
Minimum space requirements	(LxW in mm) 5964 x 4166	(LxW in mm) 5964 x 4166
Total impact area	18,1 m ²	18,1 m ²
Activities	7	6

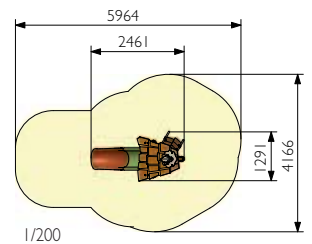

- hiding
 - shelter
 - mount
 - climb
 - cross
 - sliding
 - sporting
 - meeting
 - role game
 - handling
- Activities JPX-0001





JPX-0030

Designation	Piccolo Forestic Adaptée
Age group	1-5 years
Dimensions of equipment	(LxVxH in mm) 3850 x 1928 x 1820
Minimum space requirements	(LxW in mm) 7772 x 5309
Total impact area	28.3 m ²
Activities	5

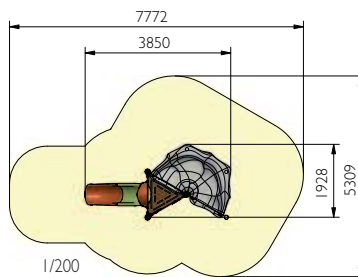

- hiding
- shelter
- mount
- climb
- cross
- sliding
- sporting
- meeting
- role game
- handling

Play equipment accessible to ALL



Piccolo presented in the theme
Forensic



JPX-0010

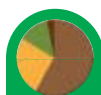

JPX-0010

Designation	Piccolo 2 Forensic
Age group	2-5 years
Dimensions of equipment	(LxVxH in mm) 3383 x 2421 x 3000
Minimum space requirements	(LxV in mm) 6431 x 5867
Total impact area	25,6 m ²
Activities	9

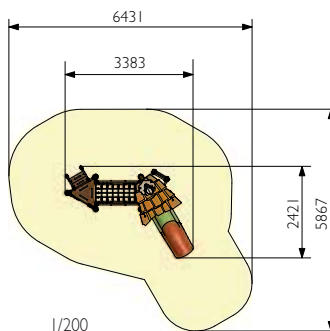

- hiding
- shelter
- mount
- climb
- cross
- sliding
- sporting
- meeting
- role game
- handling





JPX-0011



JPX-0011	
Designation	Piccolo 2 Forestic
Age group	2-5 years
Dimensions of equipment	(LxVxH in mm) 4807 x 3428 x 3410
Minimum space requirements	(LxV in mm) 7900 x 6923
Total impact area	35,5 m ²
Activities	9

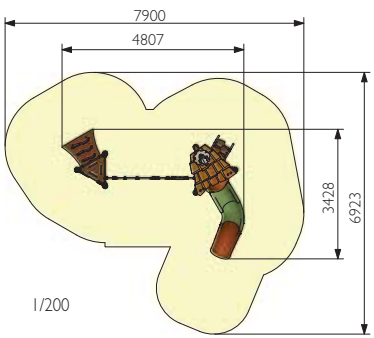

- hiding
- shelter
- mount
- climb
- cross
- sliding
- sporting
- meeting
- role game
- handling

Play equipment easily adaptable for disabled children

Piccolo presented in
the theme
Forensic



JPX-0017
Front View



JPX-0017
Rear view





JPX-0017

Designation	Piccolo 3 Forestic
Age group	2-5 years
Dimensions of equipment	(LxWxH in mm) 5350 x 3968 x 3400
Minimum space requirements	(LxW in mm) 8955 x 7317
Total impact area	44,2 m ²
Activities	12

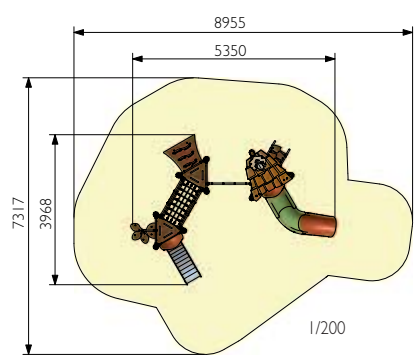

- hiding
- shelter
- mount
- climb
- cross
- sliding
- sporting
- meeting
- role game
- handling

Play equipment easily adaptable for disabled children

Piccolo presented in
the theme
Forensic



JPX-0025
Rear view



JPX-0025



JPX-0025	
Designation	Piccolo 5 Forestic
Age group	2-5 years
Dimensions of equipment	(LxVxH in mm) 7912 x 5420 x 3400
Minimum space requirements	(LxW in mm) 11059 x 8591
Total impact area	63,2 m ²
Activities	19

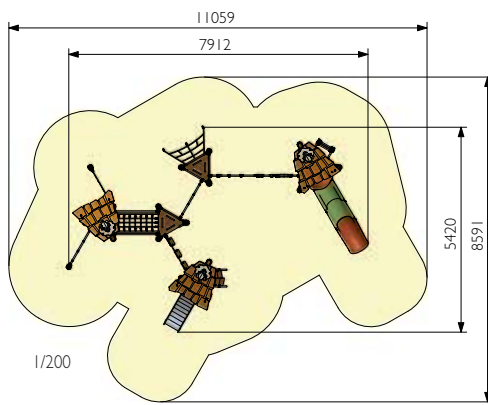

- hiding
- shelter
- mount
- climb
- cross
- sliding
- sporting
- meeting
- role game
- handling

Play equipment easily adaptable for disabled children

Piccolo presented in
the theme
Fantastic





PICCOLO
2-5 years

Piccolo presented in
the theme
Fantastic



JPX-0005
with roof



JPX-0006
roofless



JPX-0005

JPX-0006

Designation	Piccolo I Fantastic	Piccolo I Fantastic
Age group	2-5 years	2-5 years
Dimensions of equipment	(LxWxH in mm) 2644 x 2319 x 3000	(LxWxH in mm) 2074 x 1210 x 1816
Minimum space requirements	(LxW in mm) 5563 x 4166	(LxW in mm) 5563 x 4166
Total impact area	16,4 m ²	16,4 m ²
Activities	7	6

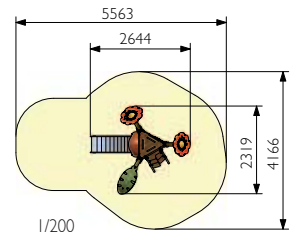

hiding



shelter



mount



climb



cross



sliding



sporting



meeting



role game



handling

JPX-0005
Activities





JPX-0007
with roof



JPX-0008
roofless



JPX-0007

JPX-0008

Designation	Piccolo I Fantastic	Piccolo I Fantastic
Age group	2-5 years	2-5 years
Dimensions of equipment	(LxWxH in mm) 3010 x 2765 x 3000	(LxWxH in mm) 2499 x 2056 x 1816
Minimum space requirements	(LxW in mm) 6031 x 5079	(LxW in mm) 5880 x 5079
Total impact area	21,6 m ²	21,6 m ²
Activities	6	4

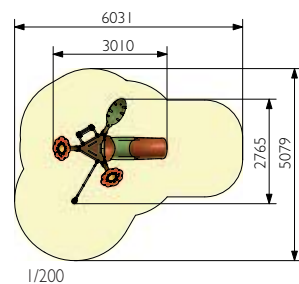

- hiding
- shelter
- mount
- climb
- cross
- sliding
- sporting
- meeting
- role game
- handling

JPX-0007
Activities



Piccolo presented in
the theme
Fantastic



JPX-0012



JPX-0012
Rear view



JPX-0012

Designation	Piccolo 2 Fantastic
Age group	2-5 years
Dimensions of equipment	(LxVxH in mm) 4754 x 3106 x 3400
Minimum space requirements	(LxW in mm) 8135 x 6092
Total impact area	36,2 m ²
Activities	11

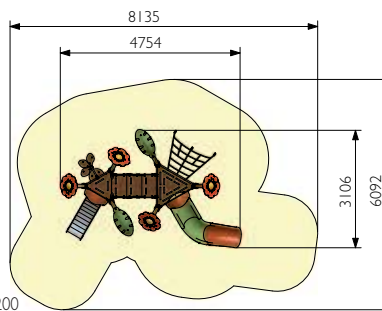

hiding



shelter



mount



climb



cross



sliding



sporting



meeting



role game



handling



Play equipment easily adaptable for disabled children





JPX-0013



JPX-0013
Rear view



JPX-0013	
Designation	Piccolo 2 Fantastic
Age group	2-5 years
Dimensions of equipment	(LxVxH in mm) 3363 x 2957 x 3000
Minimum space requirements	(LxW in mm) 6431 x 6397
Total zone of impact	27,6 m ²
Activities	9

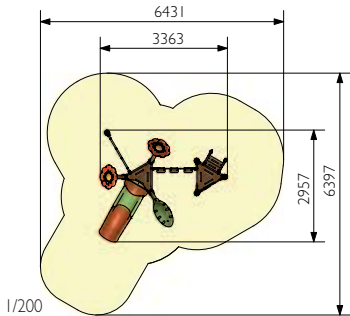

- hiding
- shelter
- mount
- climb
- cross
- sliding
- sporting
- meeting
- role game
- handling

Piccolo presented in
the theme
Fantastic



JPX-0018



JPX-0018
Rear view





JPX-0018

Designation	Piccolo 3 Fantastic
Age group	2-5 years
Dimensions of equipment	(LxVxH in mm) 5161 x 4650 x 3400
Minimum space requirements	(LxW in mm) 7712 x 7400
Total zone of impact	36,5 m ²
Activities	14

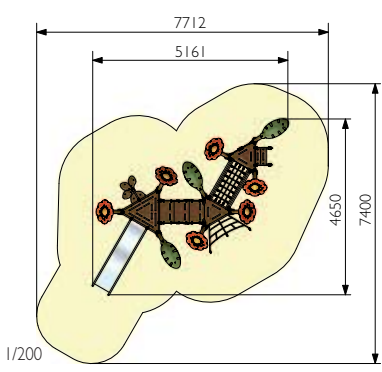

- hiding
- shelter
- mount
- climb
- cross
- sliding
- sporting
- meeting
- role game
- handling

Play equipment easily adaptable for disabled children

Piccolo presented in
the theme
Fantastic



JPX-0026
Rear view





JPX-0026

JPX-0026	
Designation	Piccolo 5 Fantastic
Age group	2-5 years
Dimensions of equipment	(LxVxH in mm) 9127 x 5880 x 3400
Minimum space requirements	(LxW in mm) 12549 x 9356
Total impact area	68,5 m ²
Activities	21

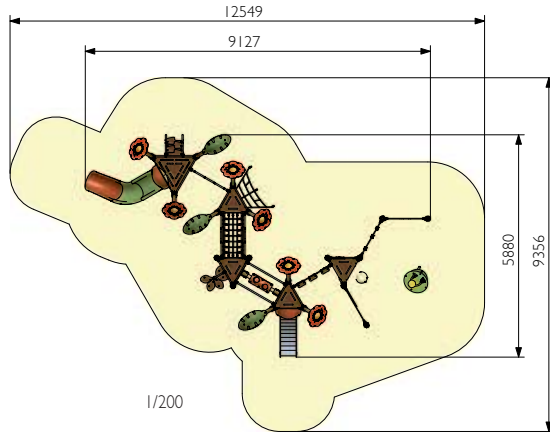

- hiding
- shelter
- mount
- climb
- cross
- sliding
- sporting
- meeting
- role game
- handling

Play equipment easily adaptable for disabled children

Piccolo presented in
the theme
Cartoon





PICCOLO
2-5 years

Piccolo presented in
the theme
Cartoon



JPX-0015

JPX-0015
Rear view



JPX-0015

Designation	Piccolo 2 Cartoon Adaptée
Age group	1-5 years
Dimensions of equipment	(LxVxH in mm) 3734 x 2389 x 2230
Minimum space requirements	(LxW in mm) 6600 x 5078
Total impact area	27,8 m ²
Activities	12

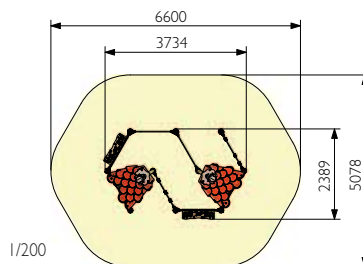

1/200



hiding



shelter



mount



climb



cross



sliding



sporting



meeting



role game



handling



Play equipment
accessible to ALL



JPX-0028



JPX-0028
Rear view



JPX-0028

Designation	Piccolo 3 Cartoon
Age group	1-5 years
Dimensions of equipment	(LxVxH in mm) 3840 x 2913 x 2790
Minimum space requirements	(LxW in mm) 6330 x 5588
Total impact area	25,6 m ²
Activities	12

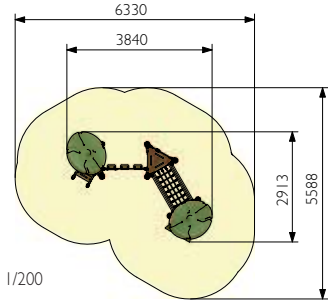

- hiding
- shelter
- mount
- climb
- cross
- sliding
- sporting
- meeting
- role game
- handling



Piccolo presented in
the theme
Cartoon



JPX-0020





JPX-0020

Designation	Piccolo 3 Cartoon
Age group	2-5 years
Dimensions of equipment	(LxWxH in mm) 4187 x 4041 x 3190
Minimum space requirements	(LxW in mm) 7194 x 7574
Total zone of impact	38,2 m ²
Activities	11

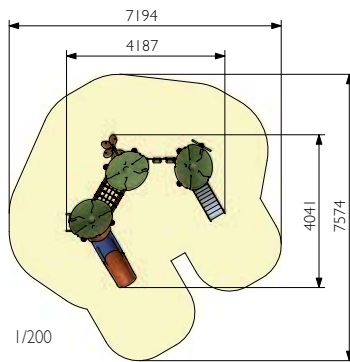

- hiding
- shelter
- mount
- climb
- cross
- sliding
- sporting
- meeting
- role game
- handling



Piccolo presented in the theme Cartoon



JPX-0027



JPX-0027
Rear view





JPX-0027

Designation	Piccolo 5 Cartoon
Age group	2-5 years
Dimensions of equipment	(LxVxH in mm) 7686 x 6332 x 3580
Minimum space requirements	(LxV in mm) 11103 x 9479
Total impact area	70,5 m ²
Activities	21

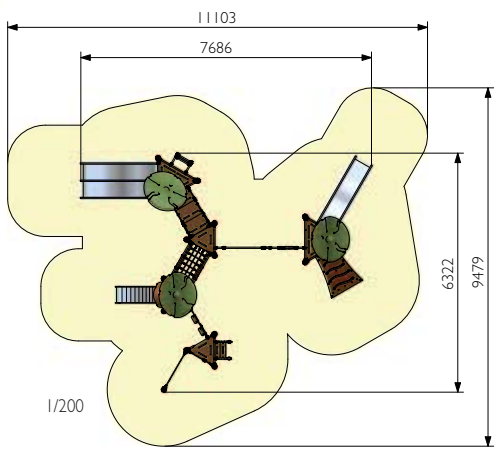

- hiding
- shelter
- mount
- climb
- cross
- sliding
- sporting
- meeting
- role game
- handling

Play equipment easily adaptable for disabled children

Cameleo

is **FUN!**

Cameleo is an exclusive concept with the ability to adapt and change to suit any location and to give our young adventure-hungry explorers a real treat.

+ Ideas

Play equipment designed for **4 to 10-year olds**.
Certain CAMELEO configurations are suitable for small children from the age of three.
Made-to-measure configurations can be created thanks to the exclusive HUSSON modular construction system.

+ Design

For a very good integration of play equipment in all landscapes and for the delight of all, Cameleo offers a choice of 5 themes...

+ Fun

Full of new fun activities:

- **Interactive games such as:**

The sketcher: The wheel turns and when it stops, it points to two figurines that the children must go and find on the CAMELEO play equipment.

- **"Adventure trails" and climbing routes:**

Four to ten year-olds are keen on challenges and they love climbing, acrobatics and sliding.

CAMELEO has been designed so that they can progress and surpass their limits in complete safety.

- **Meeting and role-playing:**

CAMELEO offers new activities for encouraging children to play together.

A little bit, "like a chameleon"
The CAMELEO concept
can be adapted to all sites
and environments ...





CAMELEO
4-10 years



Cameleo

decorated in one of 5 possible themes:

+ Design

CAMELEO offers a choice of 5 themes, so that play equipment can be perfectly integrated into all landscapes at the same time offering fun and excitement to children and parents alike. Any child will love becoming Robin Hood, a magician, a hero, a pirate or knight and living out the most magical adventures in his or her new world of make-believe.



Forensic

Pages 64 to 75



Fantastic

Pages 76 to 85





CAMELEO
4-10 years



CAMELEO The technical +

1 - A highly modular system:

- With over 200 different component elements for creating made-to-measure play equipment, the installation can be extended in stages, allowing the playground to grow and evolve over time.

2- An assembly system* using multi-D+ clamps:

- Made in die cast aluminium
- Elegant design: Up to four components can be fitted to the same multidirectional collar
- Rounded shapes for even greater safety
- Extremely robust thanks to its double bolt fixing system
- Posts with adjustable ground fixing legs for ease of installation.

3- Even more safety:

- **CAMELEO** play equipment is designed to meet the new European EN 1176 standards, version 2008.
- Compliance with standards is guaranteed by internal quality management systems and certification issued by an independent control laboratory (Prélud, TUV or Pourquery).
- Pushing concern for safety to the highest possible levels, **CAMELEO** play equipment often far exceeds the minimum requirements of standards and regulations in force, especially concerning the integral strength of the main structure...

4- Toughness designed in HUSSON:

- CAMELEO play equipment is as tough as it is aesthetic with. A galvanized steel framework designed to last for 30 years!

5- Top-quality materials:

- An extremely robust steel structure far exceeding the minimum requirements of standards in force.
- Many elements manufactured in stainless steel as the standard option.
- Panels in multicoloured HPL specially designed for HUSSON: Solid high-pressure laminate, highly resistant (15mm thick), rot-resistant, with low-flammability levels and colour-through material.
- Components are moulded in extra-thick HDPE (High Density Polyethylene) for maximum toughness. This material is colour-through and requires minimal maintenance.
- A wide range of slides in steel/stainless steel or HPL/stainless steel or moulded HDPE.
- New netting strands with steel cores covered with a thick coat of 3-color polyamide (exclusive to HUSSON).
- Special "one tool fits all", vandal proof fasteners (exclusive to HUSSON for maximum vandal resistance).

6- Exceptional surface finish for steel elements:

- Treatment n° 1: hot-dip galvanising after fabrication (all surfaces, both inside and outside steel tubes).
- Treatment n° 2: powder coating (oven-baked polyester powder paint).

This double surface treatment is highly resistant in the harshest conditions as well as to individual acts of vandalism.

7- A 10-year guarantee:

- Parts covered by guarantee: Metal framework (uprights and assembly parts) HPL panels and flooring.
- For the terms and conditions of HUSSON guarantees: please refer to HUSSON's general conditions of sale (on the back pages of the current price list).

8- Minimal maintenance:

- Use of stainless steel and galvanized mild steel as well as the unique multi-D+ assembly system* (common across all the HUSSON ranges) is the solution for a minimal, low cost maintenance routine ensuring that your play equipment is safe to use for many years to come.

9- Encouraging sustainable development:

- All materials and surface coatings are ecologically inert, i.e. they remain environment-friendly throughout their service life and can then be easily recycled, as is the case for steel.
- HUSSON play equipment is renowned for its long life, another crucial aspect of sustainable development!

10- A smart system:

- The equipment's shapes, themes, colours and integral structural openness make it easy to integrate **CAMELEO** play equipment harmoniously into almost any environment...

* Patented system





CAMELEO
4-10 years



Camelto presented in
the theme
Forestic

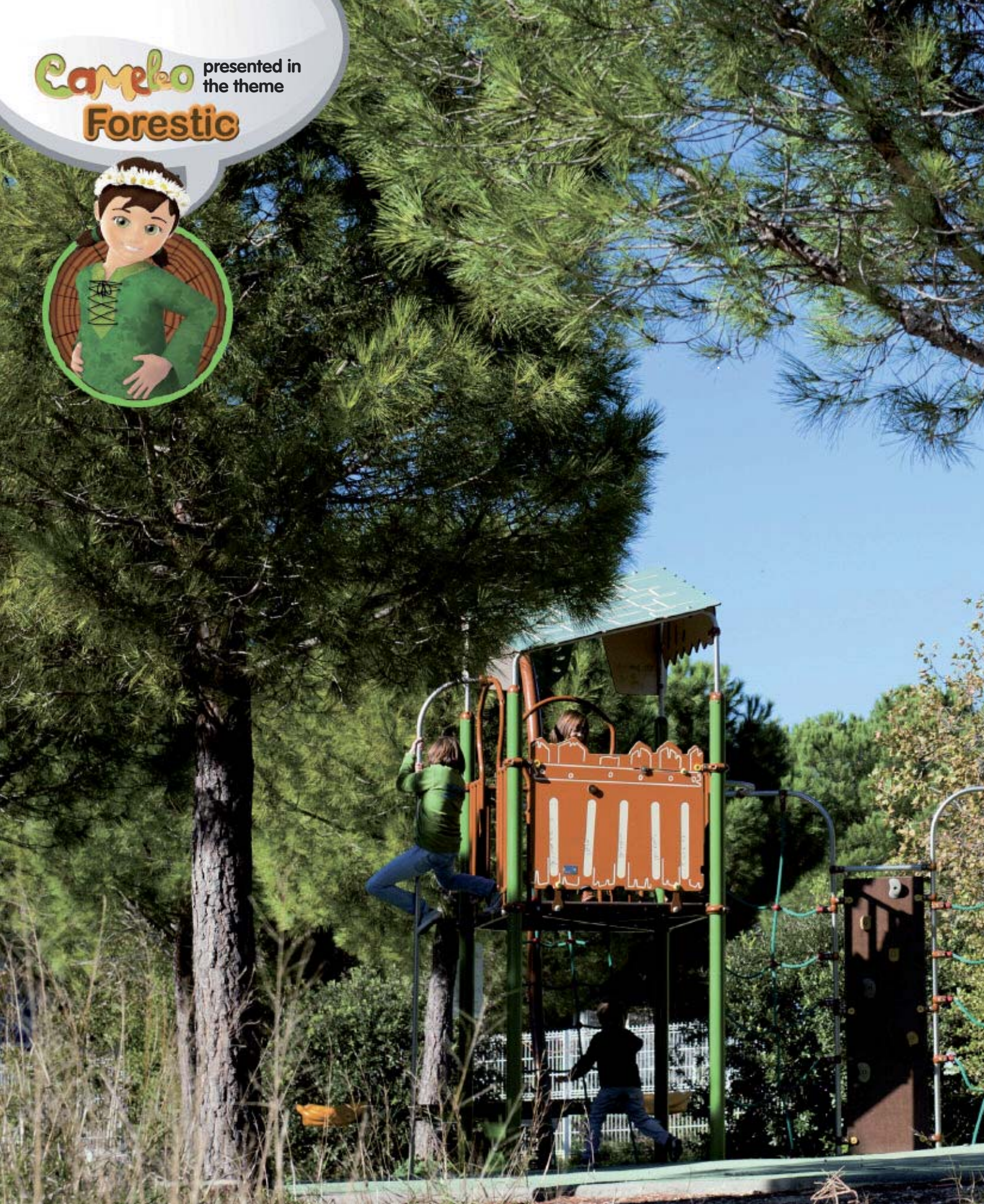



CAMELEO
4-10 years

presented in
the theme

Cameleo Forestic



JCX-001



JCX-001

Designation	Cameleo 1 Forestic
Age group	4-10 years
Dimensions of equipment	(LxVxH in mm) 5242 x 2835 x 4060
Minimum space requirements	(LxV in mm) 9348 x 6695
Total impact area	38,4 m ²
Activities	10

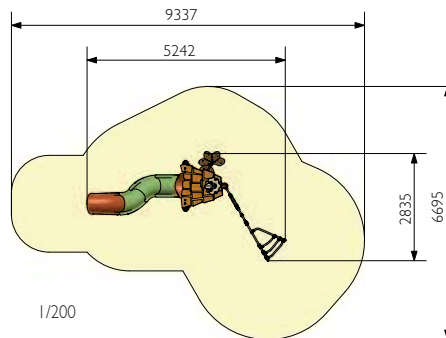

- 1 hiding
- 1 shelter
- 2 mount
- 1 climb
- cross
- 1 sliding
- 1 sporting
- meeting
- 1 role game
- 2 handling





CAMELEO
4-10 years

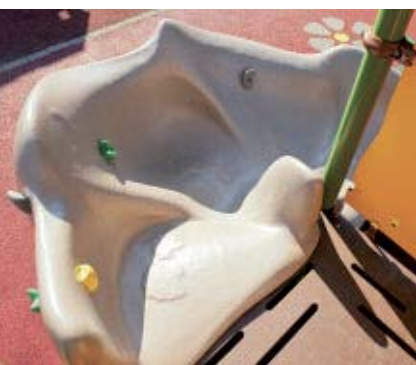

JCX-0038

Designation	Cameleo 1 Forestic Adaptée
Age group	4-10 Jahre
Dimensions of equipment	(LxVxH in mm) 4102 x 2901 x 3280
Minimum space requirements	(LxV in mm) 7602 x 5776
Total impact area	30,5 m ²
Activities	8

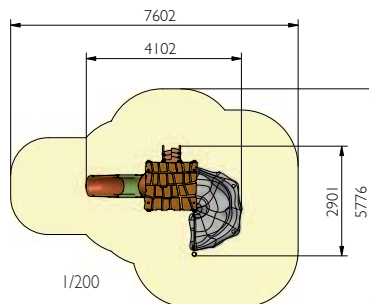

- hiding
- shelter
- mount
- climb
- cross
- sliding
- sporting
- meeting
- role game
- handling



Play equipment accessible to ALL



presented in
the theme

Cameleo Forestic



JCX-0006



JCX-0006

Designation	Cameleo 2 Forestic
Age group	4-10 years
Dimensions of equipment	(LxVxH in mm) 7458 x 4496 x 4110
Minimum space requirements	(LxV in mm) 11325 x 7470
Total impact area	56,2 m ²
Activities	12

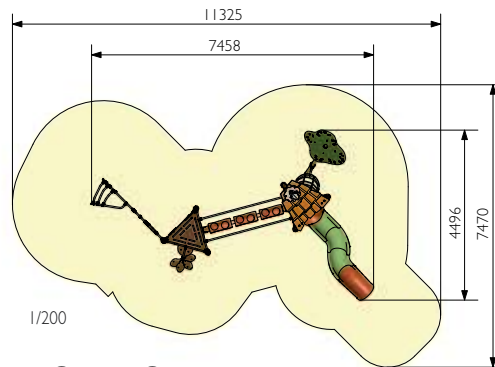









CAMELEO
4-10 years

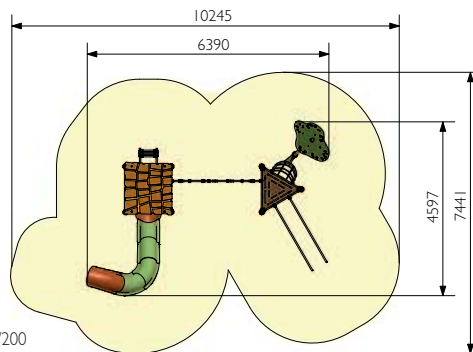

JCX-0007

Designation	Cameleo 2 Forestic
Age group	4-10 years
Dimensions of equipment	(LxWxH in mm) 6390 x 4597 x 4480
Minimum space requirements	(LxW in mm) 10245 x 7441
Total impact area	58,3 m ²
Activities	11



-  hiding
-  shelter
-  mount
-  climb
-  cross
-  sliding
-  sporting
-  meeting
-  role game
-  handling



Play equipment easily adaptable for disabled children



presented in
the theme

Campele Forestic



JCX-0017
Rear View





CAMELEO
4-10 years



JCX-0017

Designation	Cameleo 3 Forestic
Age group	4-10 years
Dimensions of equipment	(LxWxH in mm) 6893 x 6566 x 4110
Minimum space requirements	(LxW in mm) 10336 x 9178
Total impact area	66,8 m ²
Activities	16

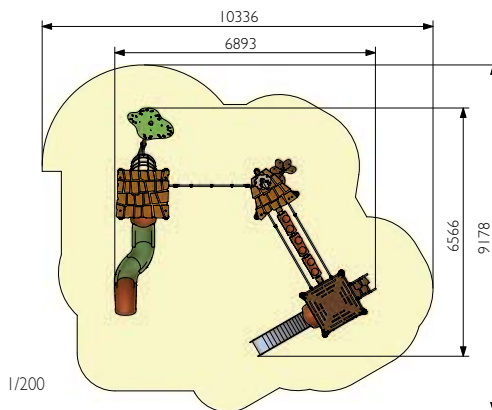

- 1 hiding
- 2 shelter
- 3 mount
- 1 climb
- 1 cross
- 2 sliding
- 1 sporting
- 1 meeting
- 1 role game
- 3 handling

Play equipment easily adaptable for disabled children



presented in
the theme

Cameleo Forestic



JCX-0027

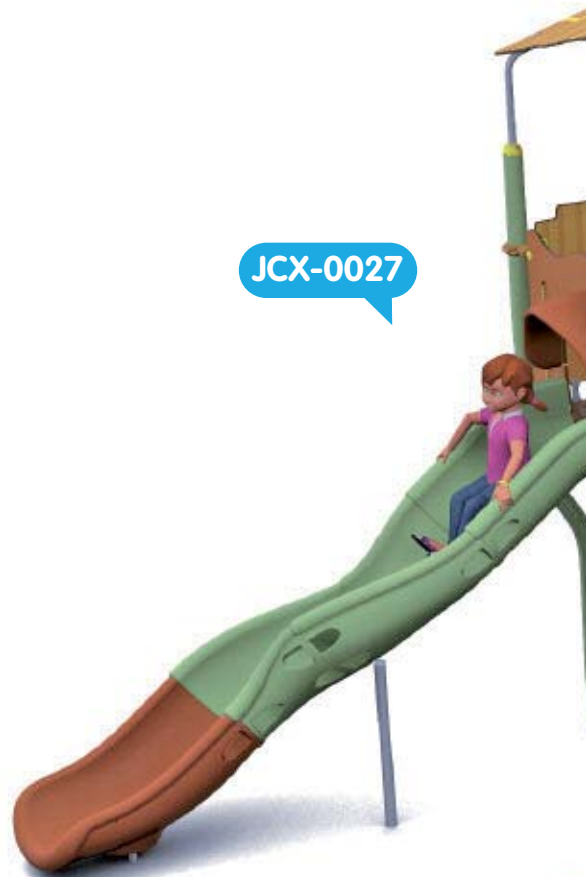

JCX-0027
Rear View



JCX-0027

Designation	Cameleo 4 Forestic
Age group	4-10 years
Dimensions of equipment (LxVxH in mm)	6902 x 8810 x 4110
Minimum space requirements (LxV in mm)	10336 x 12054
Total impact area	87,1 m ²
Activities	23



hiding



shelter



mount



climb



cross



sliding



sporting



meeting



role game



handling



Play equipment
easily adaptable for
disabled children





CAMELEO
4-10 years

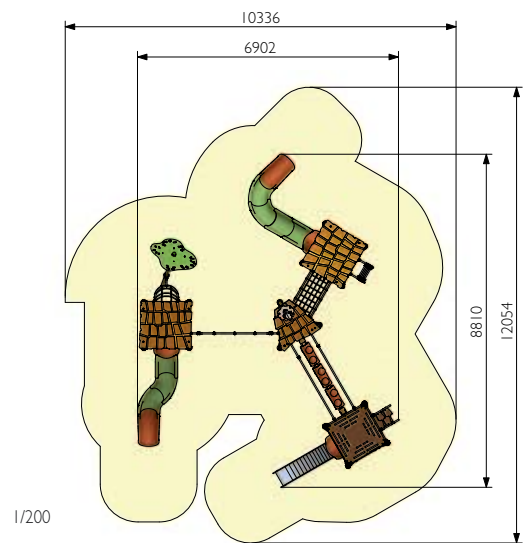

Camelo Forestic

presented in
the theme



JCX-0032
Rear View





JCX-0032

CAMELEO
4-10 years



JCX-0032

Designation	Cameleo 5 Forestic
Age group	4-10 years
Dimensions of equipment	(LxWxH in mm) 12218 x 9197 x 4880
Minimum space requirements	(LxW in mm) 15976 x 12557
Total impact area	114,1 m ²
Activities	30

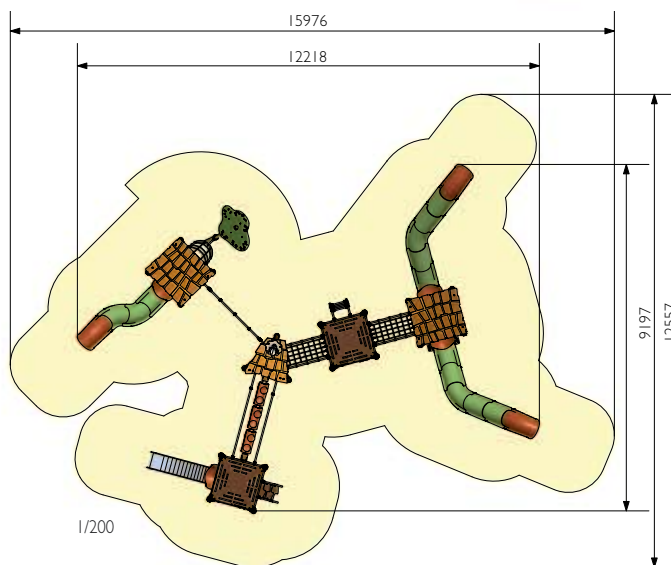

- hiding
- shelter
- mount
- climb
- cross
- sliding
- sporting
- meeting
- role game
- handling

Play equipment easily adaptable for disabled children



Camelto presented in
the theme
Fantastic





CAMELEO
4-10 years

Cameleo presented in
the theme
Fantastic



JCX-0002



JCX-0002	
Designation	Cameleo 1 Fantastic
Age group	4-10 years
Dimensions of equipment	(LxVxH in mm) 5322 x 3520 x 4350
Minimum space requirements	(LxV in mm) 9157 x 7178
Total impact area	41,7 m ²
Activities	11

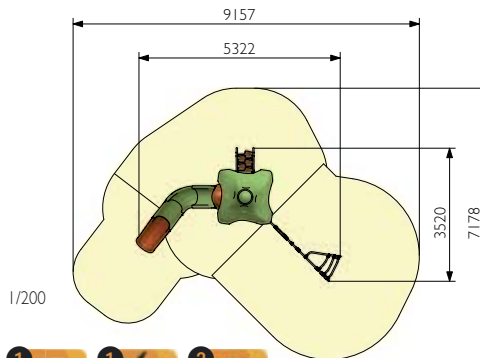

- hiding
- shelter
- mount
- climb
- cross
- sliding
- sporting
- meeting
- role game
- handling





JCX-0037

CAMELEO
4-10 years



JCX-0037

Designation	Cameleo 1 Fantastic
Age group	4-10 years
Dimensions of equipment	(LxVxH in mm) 3488 x 1962 x 3420
Minimum space requirements	(LxV in mm) 6938 x 4868
Total impact area	24,3 m ²
Activities	9

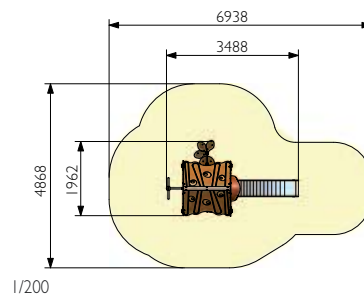

hiding



shelter



mount



climb



cross



sliding



sporting



meeting



role game



handling



Play equipment easily adaptable for disabled children



presented in
the theme
Camelco Fantastic

JCX-0008

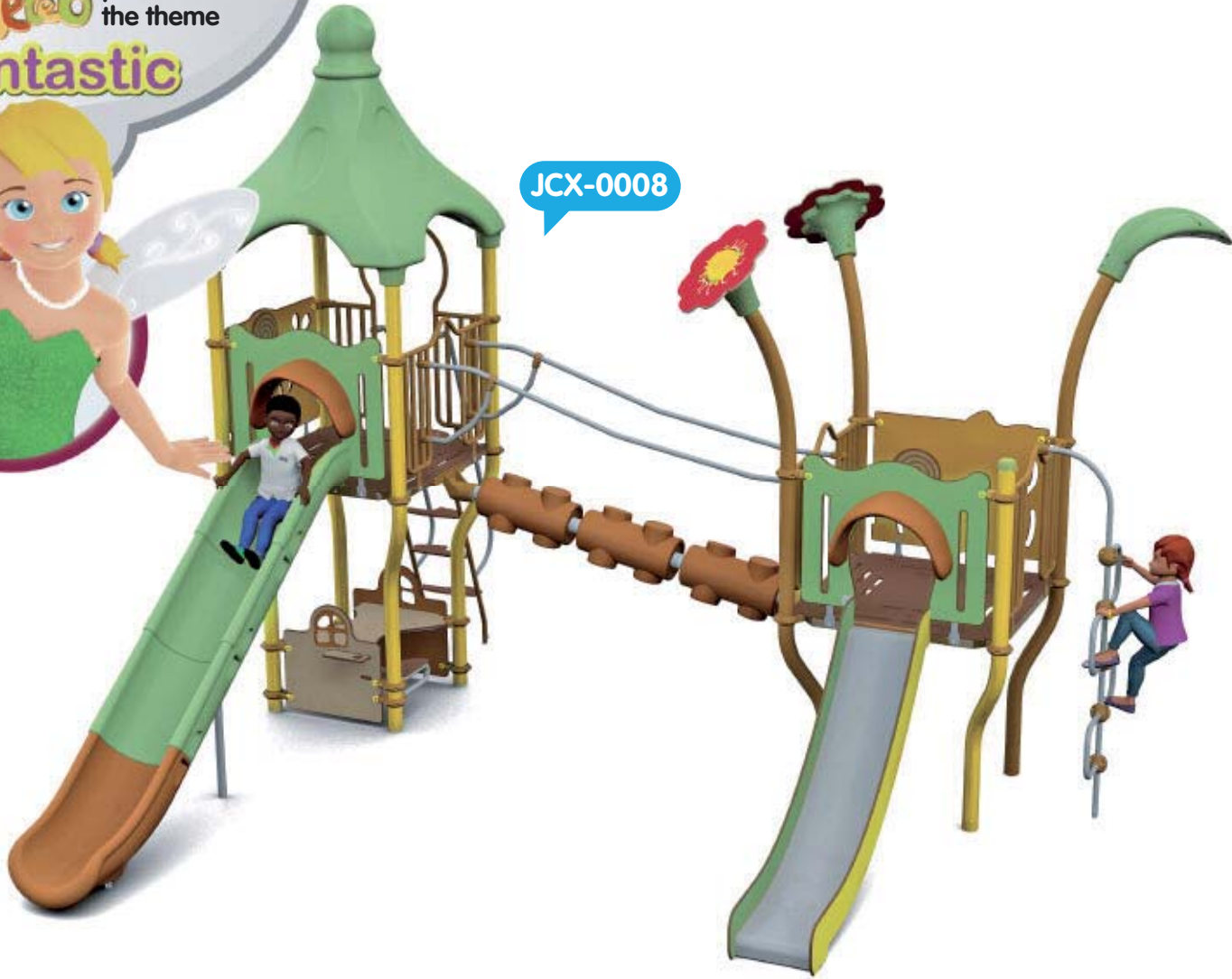

JCX-0008

Designation	Camelco 2 Fantastic
Age group	4-10 years
Dimensions of equipment	(LxVxH in mm) 5664 x 4673 x 4350
Minimum space requirements	(LxV in mm) 8374 x 8230
Total impact area	49,8 m ²
Activities	13

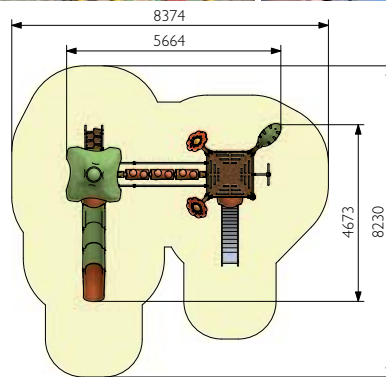

- 
hiding
- 
shelter
- 
mount
- 
climb
- 
cross
- 
sliding
- 
sporting
- 
meeting
- 
role game
- 
handling













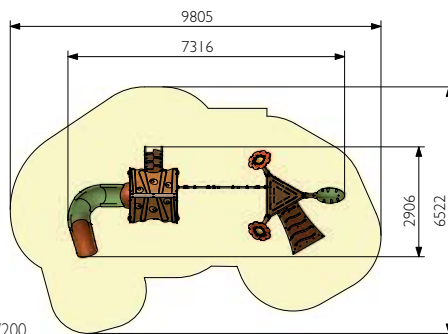

CAMELEO
4-10 years



JCX-0009

Designation	Cameleo 2 Fantastic
Age group	4-10 years
Dimensions of equipment	(LxVxH in mm) 7316 x 2906 x 3820
Minimum space requirements	(LxV in mm) 9805 x 6522
Total impact area	44,2 m ²
Activities	14



-  hiding
-  shelter
-  mount
-  climb
-  cross
-  sliding
-  sporting
-  meeting
-  role game
-  handling



Play equipment easily adaptable for disabled children



Camelco presented in
the theme
Fantastic

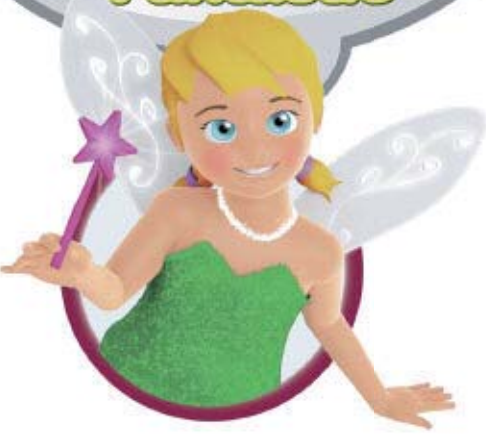

JCX-0019
Rear View





JCX-0019







CAMELEO
4-10 years

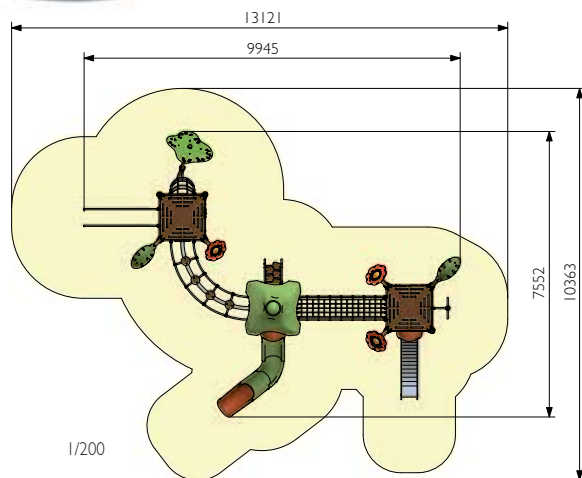





JCX-0019

Designation	Cameleo 3 Fantastic
Age group	4-10 years
Dimensions of equipment	(LxVxH in mm) 9945 x 7552 x 4350
Minimum space requirements	(LxV in mm) 13121 x 10363
Total impact area	79 m ²
Activities	20



-  1 hiding
-  3 shelter
-  2 mount
-  2 climb
-  2 cross
-  3 sliding
-  1 sporting

-  meeting
-  1 role game
-  4 handling

 Play equipment easily adaptable for disabled children



Camelco presented in
the theme
Fantastic



JCX-0033
Rear View





JCX-0033

CAMELEO
4-10 years



JCX-0033

Designation	Cameleo 5 Fantastic
Age group	4-10 years
Dimensions of equipment	(LxVxH in mm) 14174 x 6917 x 4350
Minimum space requirements	(LxV in mm) 17165 x 10283
Total impact area	110,4 m ²
Activities	26

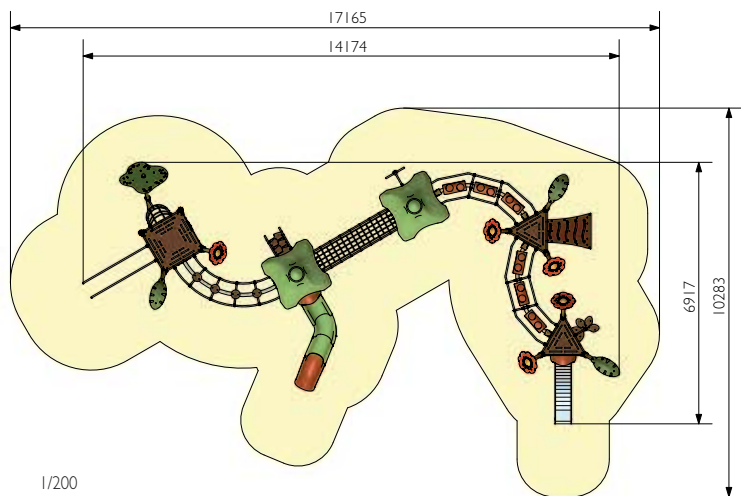

1/200

- hiding
- shelter
- mount
- climb
- cross
- sliding
- sporting
- meeting
- role game
- handling

Play equipment easily adaptable for disabled children



Camelco presented in
the theme
Cartoon





CAMELEO
4-10 years

Cameleo presented in the theme
Cartoon

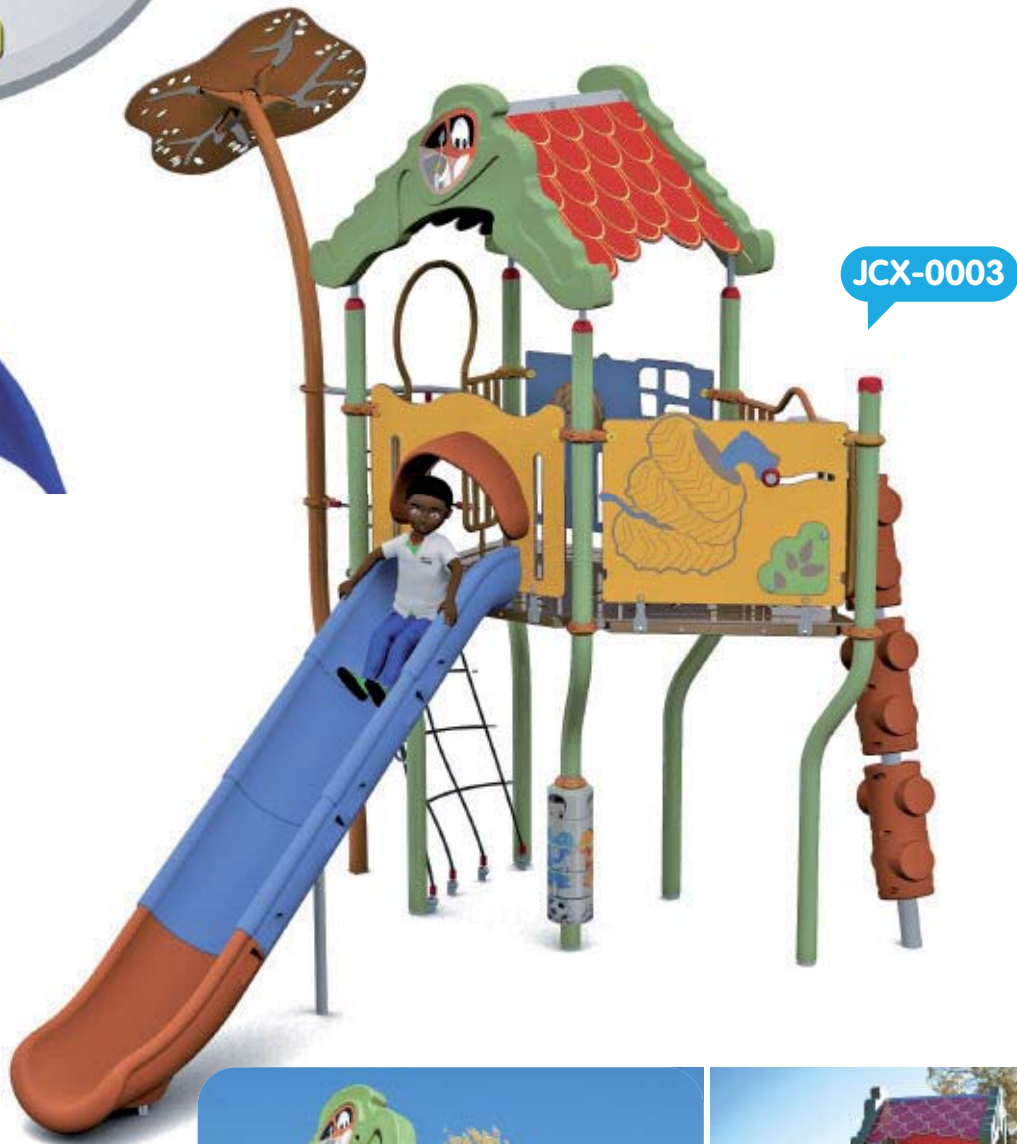

JCX-0003



JCX-0003

Designation	Cameleo Cartoon
Age group	4-10 years
Dimensions of equipment	(LxVxH in mm) 4210 x 4031 x 3860
Minimum space requirements	(LxV in mm) 8181 x 7122
Total impact area	38,3 m ²
Activities	10

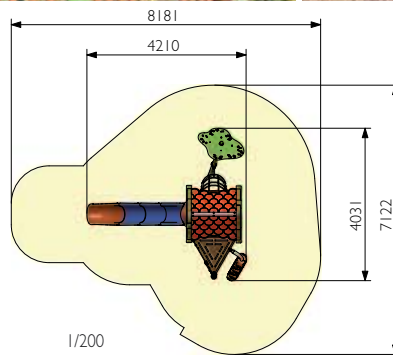

- hiding
- shelter
- mount
- climb
- cross
- sliding
- sporting
- meeting
- role game
- handling





JCX-0039

JCX-0039
Rear View



JCX-0039

Designation	Cameleo 2 Cartoon Adaptée
Age group	1-10 years
Dimensions of equipment	(LxVxH in mm) 3873 x 2673 x 2370
Minimum space requirements	(LxV in mm) 6600 x 5400
Total impact area	33,8 m ²
Activities	13

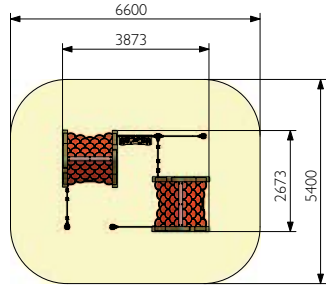

1/200

-
-
-
-
-
-
-
-
-
-

Play equipment accessible to ALL

presented in
the theme
Cartoon



JCX-0010

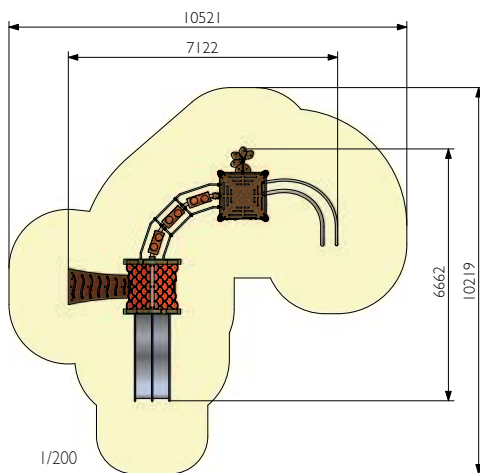

JCX-0010

Designation	Cameleo 2 Cartoon
Age group	4-10 years
Dimensions of equipment	(LxWxH in mm) 7122 x 6662 x 3860
Minimum space requirements	(LxW in mm) 10521 x 10219
Total impact area	61,4 m ²
Activities	15

- 1 hiding
- 1 shelter
- 2 mount
- 1 climb
- 1 cross
- 3 sliding
- 1 sporting
- 1 meeting
- 1 role game
- 3 handling



Play equipment
easily adaptable for
disabled children





JCX-0011

CAMELEO
4-10 years



JCX-0011

Designation	Cameleo 2 Cartoon
Age group	4-10 years
Dimensions of equipment	(LxVxH in mm) 6841 x 3306 x 4450
Minimum space requirements	(LxV in mm) 10766 x 6851
Total impact area	54,6 m ²
Activities	13

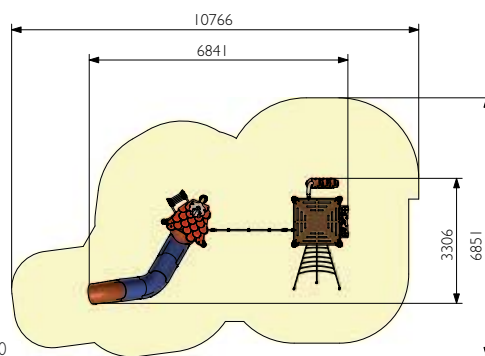

hiding

shelter

mount

climb

cross

sliding

sporting

meeting

role game

handling

JCX11



www.husson.eu

91

Camelo presented in the theme
Cartoon





CAMELEO
4-10 years



JCX-0021

Designation	Cameleo 3 Cartoon
Age group	3-10 years
Dimensions of equipment	(LxVxH in mm) 9229 x 6889 x 3860
Minimum space requirements	(LxW in mm) 12271 x 10379
Total impact area	69,5 m ²
Activities	18

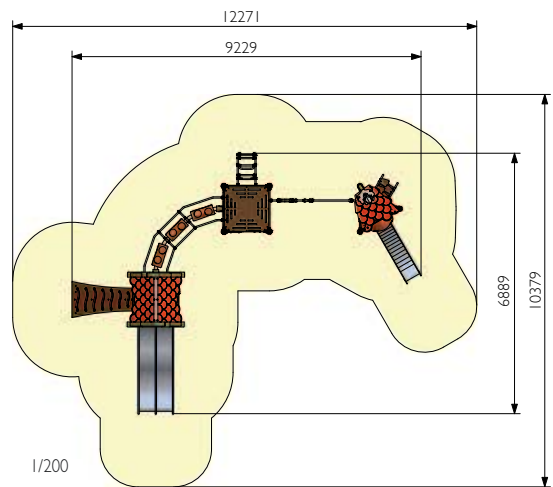

-  1 hiding
-  2 shelter
-  3 mount
-  1 climb
-  1 cross
-  3 sliding
-  1 sporting
-  1 meeting
-  1 role game
-  4 handling



Play equipment easily adaptable for disabled children



Camelo presented in the theme
Cartoon



JCX-0029



JCX-0029
Rear View





JCX-0029

Designation	Cameleo 4 Cartoon
Age group	4-10 years
Dimensions of equipment	(LxVxH in mm) 10005 x 8603 x 4260
Minimum space requirements	(LxW in mm) 13716 x 12389
Total impact area	109 m ²
Activities	29

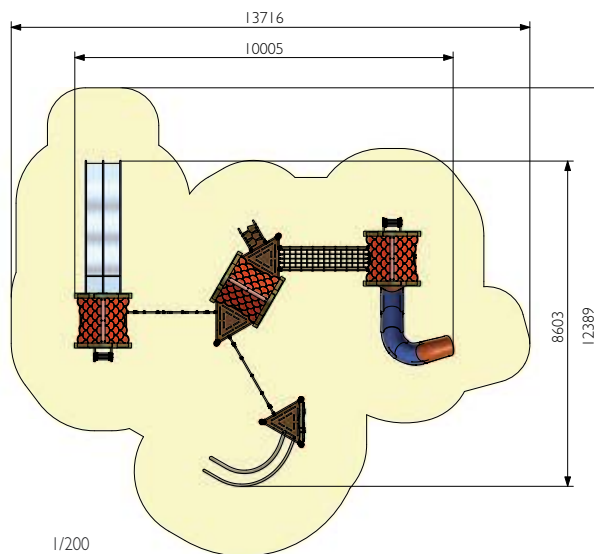

- 1 hiding
- 3 shelter
- 4 mount
- 2 climb
- 1 cross
- 4 sliding
- 1 sporting
- 2 meeting
- 1 role game
- 1 handling



Play equipment easily adaptable for disabled children



Camelo presented in
the theme
Aquatic





CAMELEO
4-10 years

presented in the theme
Cameleo Aquatic



JCX-0004



JCX-0004

Designation	Cameleo 1 Aquatic
Age group	3-10 years
Dimensions of equipment	(LxVxH in mm) 4193 x 1919 x 3460
Minimum space requirements	(LxV in mm) 7625 x 4779
Total impact area	26,9 m ²
Activities	8

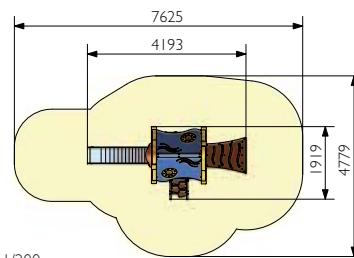

1/200



hiding



shelter



mount



climb



cross



sliding



sporting



meeting



role game



handling



Play equipment easily adaptable for disabled children



JCX-0013

CAMELEO
4-10 years



JCX-0013	
Designation	Cameleo 2 Aquatic
Age group	4-10 years
Dimensions of equipment	(LxVxH in mm) 6259 x 6109 x 4110
Minimum space requirements	(LxV in mm) 9695 x 9102
Total impact area	59,4 m ²
Activities	13

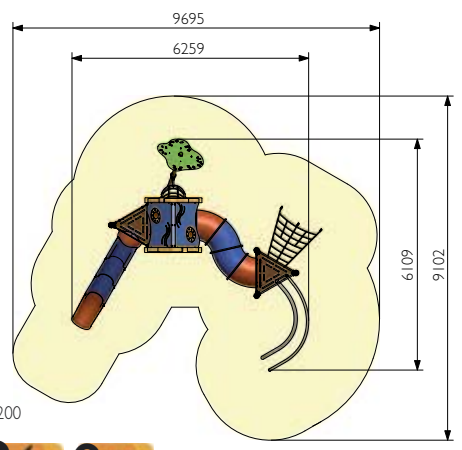

- hiding
- shelter
- mount
- climb
- cross
- sliding
- sporting
- meeting
- role game
- handling

Camelo presented in the theme Aquatic



JCX-0030



JCX-0030 Rear View





CAMELEO
4-10 years



JCX-0030

Designation	Cameleo 4 Aquatic
Age group	3-10 years
Dimensions of equipment	(LxWxH in mm) 7500 x 6924 x 4110
Minimum space requirements	(LxW in mm) 10131 x 10789
Total impact area	61,6 m ²
Activities	15

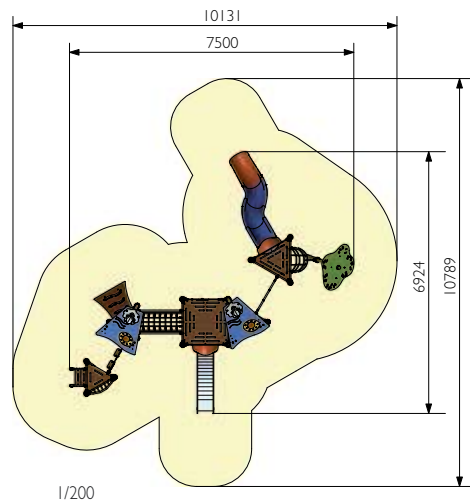

- 1 hiding
- 2 shelter
- 3 mount
- 1 climb
- 2 cross
- 2 sliding
- 1 sporting
- 1 meeting
- 1 role game
- 1 handling



Play equipment easily adaptable for disabled children



Camelo
Historic

presented in
the theme





CAMELEO
4-10 years

presented in
the theme

Cameleo Historic



JCX-0005



JCX-0005

Designation	Cameleo 1 Historic
Age group	4-10 years
Dimensions of equipment	(LxVxH in mm) 3853 x 2731 x 3720
Minimum space requirements	(LxV in mm) 7095 x 6269
Total impact area	30,6 m ²
Activities	10

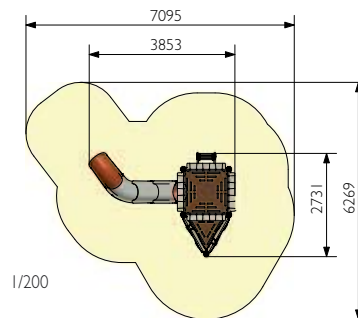

hiding



shelter



mount



climb



cross



sliding



sporting



meeting



role game



handling





JCX-0016

CAMELEO
4-10 years



JCX-0016

Designation	Cameleo 2 Historic
Age group	4-10 years
Dimensions of equipment	(LxVxH in mm) 6760 x 3853 x 3720
Minimum space requirements	(LxV in mm) 10278 x 7095
Total impact area	57,6 m ²
Activities	16

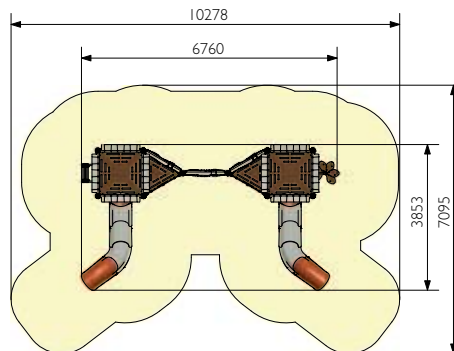

1/200



Camelo
Historic

presented in
the theme

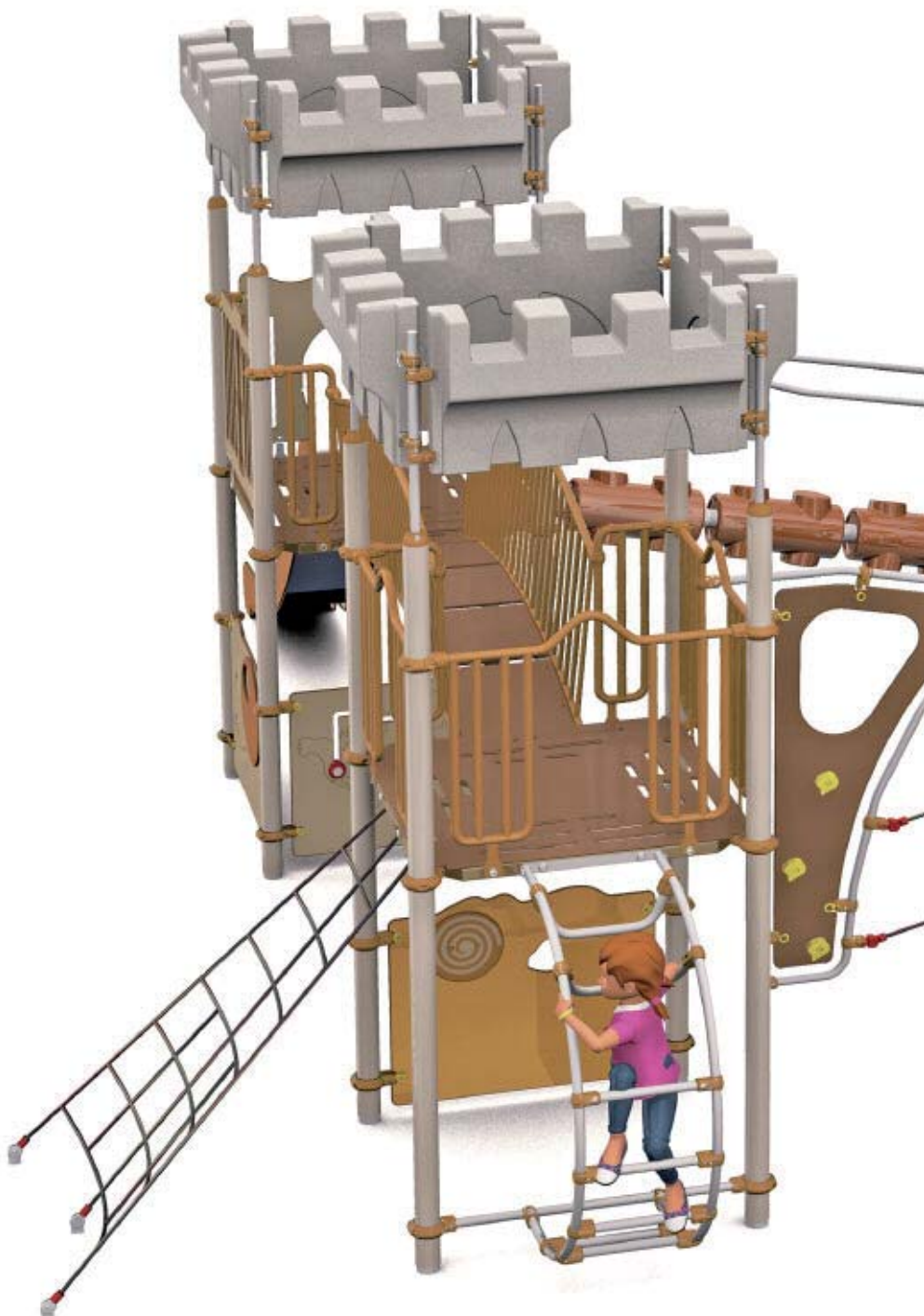

JCX-0031
Rear View





JCX-0031

CAMELEO
4-10 years

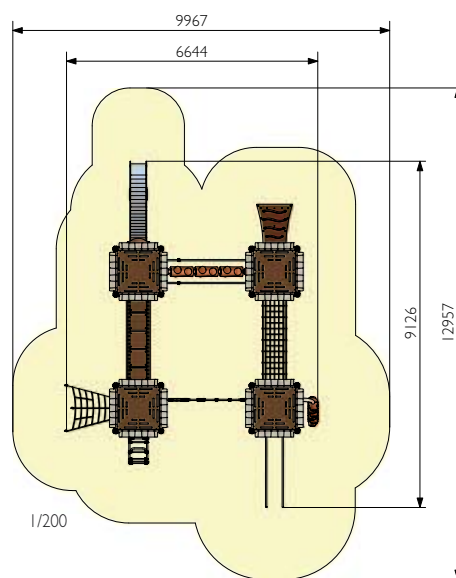

JCX-0031

Designation	Cameleo 4 Historic
Age group	4-10 years
Dimensions of equipment	(LxVxH in mm) 9126 x 6644 x 3720
Minimum space requirements	(LxV in mm) 12957 x 9967
Total impact area	90,1 m ²
Activities	22

- 1 hiding
- 4 shelter
- 3 mount
- 2 climb
- 3 cross
- 2 sliding
- 1 sporting
- 1 meeting
- 1 role game
- 5 handling



Play equipment easily adaptable for disabled children



CAMELEO XL

it's the **TOP!**

New fun and fantastic worlds at the very limits of imagination, for big and small alike!

+ Ideas

- Play equipment designed for **4 to 12 year olds**.
- Equipment between 5 and 10 meters high.
- Safety: Total peace of mind with totally enclosed accesses and slides for floors over 2.50 meters high.
- **CAMELEO XL** has grown and evolved out of the **CAMELEO** range and uses many of its components, it thus possesses the flexibility and modularity of the **CAMELEO** concept.

+ Design

CAMELEO XL benefits from a well thought-out design with great attention to detail. This, coupled with a stunning complimentary colour scheme, is most certainly an asset to any public, theme or holiday park.

+ Fun

The new large **CAMELEO XL** towers have been designed to give children even more thrills, in total safety:

- Climbing routes that go up to... the summits!
- Breathtaking slides that finish ... very gently!
- New imaginary worlds for budding explorers, actors, adventurers or Robin Hoods!

*Patented "Multi-D+" assembly system



Up high, in complete safety. Thrilling rides down to the ground!



CAMELEO XL
4-12 years

Camelot XL



JGT-0001



CAMELEO XL
4-12 years

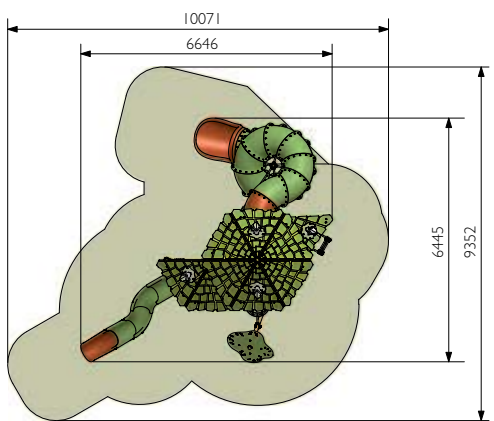

JGT-0001

Designation	Cameleo XL I Forestic
Age group	4-12 years
Dimensions of equipment	(LxVxH in mm) 6646 x 6445 x 6730
Minimum space requirements	(LxW in mm) 10071 x 9352
Total impact area	59,2 m ²
Activities	15

-  hiding
-  shelter
-  mount
-  climb
-  cross
-  sliding
-  sporting
-  meeting
-  role game
-  handling



Camelot XL



JGT-0045
Rear view



JGT-0045



CAMELEO XL
4-12 years



JGT-0045

Designation	Cameleo XL 2 Forestic
Age group	4-12 years
Dimensions of equipment	(LxVxH in mm) 12767 x 7983 x 6730
Minimum space requirements	(LxW in mm) 16400 x 11971
Total impact area	115,2 m ²
Activities	25

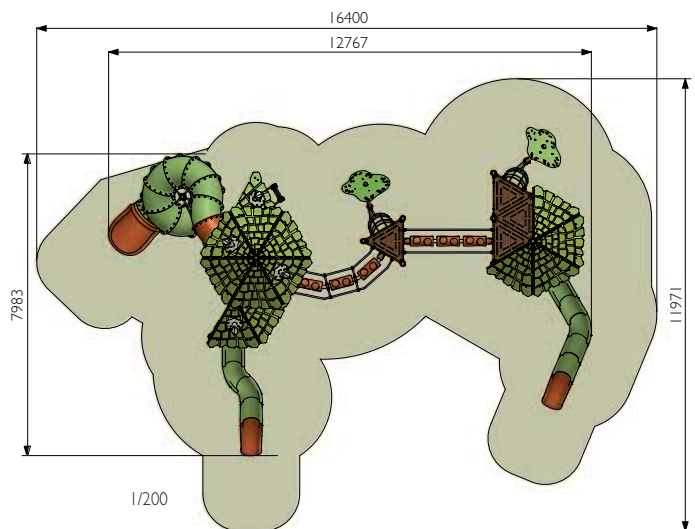



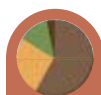





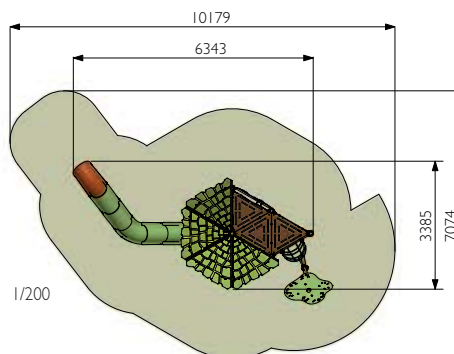

Cameleo XL



JGT-0048

Designation	Cameleo XL I Forestic
Age group	4-12 years
Dimensions of equipment	(LxVxH in mm) 6343 x 3385 x 5010
Minimum space requirements	(LxV in mm) 10179 x 7074
Total impact area	48,3 m ²
Activities	13



-  hiding
-  shelter
-  mount
-  climb
-  cross
-  sliding
-  sporting
-  meeting
-  role game
-  handling





CAMELEO XL
4-12 years

Vertigo

**7 to 14 year-olds,
developing a sense
of independence!**

Older children start to develop a sense of their own identity and a sense of their own independence.

As physical challenges are now a fun part of their daily life, VERTIGO has been designed to enable them to surpass their limits in complete safety.





VERTIGO
7-14 years



Vertigo

VERTIGO, this is the area specifically designed for older children and pre-adolescents in developing a fun, competitive spirit.

+ Ideas

VERTIGO modular games are designed for older children from **7 to 14 years old**. Highly modular and extendable, with 50 elements / activities, **VERTIGO** offers the possibility of creating made-to-measure playgrounds, from small structures to large circuits in an activity trail type concept.

+ Design

The equipment's shapes, themes, colours and integral structural openness make it easy to integrate Vertigo play equipment harmoniously in to almost any environment.

There are a choice of 3 themes available.

+ Fun

Studied, drawn and made in association with and for children and teenagers: not surprising that **VERTIGO** is appreciated so much!

Just like all its climbing, balancing and sliding possibilities





VERTIGO
7-14 years



1- A new concept:

- **VERTIGO** uprights are more than just simple structural elements; they become part of challenging climbing units that also offer the chance to pause and socialize.

2- A highly modular system:

- With over 50 activities/elements, for creating made-to-measure playgrounds.

3- An assembly system* using multi-D+ clamps:

- Made in die cast aluminium
- Elegant design: Up to four components can be fitted to the same multidirectional collar
- Rounded shapes for even greater safety
- Extremely robust with its double bolt fixing system

4- Safety:

- **VERTIGO** play equipment is designed to meet the new European EN 1176 standards, version 2008.

5- Top-quality materials and surface treatment:

- **VERTIGO** play equipment is mainly made from steel with a double protective coating of exceptional quality (hot-dip galvanising + oven-baked polyester powder paint) and stainless steel.
- Netting strands have a steel core covered with a thick coat of 3-colour polyamide (Exclusive to HUSSON).

6- A 10-year guarantee:

- Parts guaranteed: Metal framework (uprights and assembly elements) components in stainless steel or HPL.
- For the terms and conditions of HUSSON guarantees: please refer to HUSSON's general conditions of sale (on the back pages of the current price list).

7- Minimal maintenance:

- Use of galvanized mild steel as well as the unique multi-D+ assembly system* (common across all the HUSSON ranges) is the solution for a minimal, low cost maintenance routine ensuring that your play equipment is safe to use for many years to come.

8- Encouraging sustainable development:

- All materials and surface coatings are ecologically inert, i.e. they remain environment-friendly throughout their service life and can then be easily recycled, as is the case for steel.
- HUSSON play equipment is renowned for its long life, another crucial aspect of sustainable development!

*Exclusive patented system



Decorated in 3 possible themes

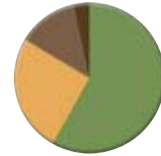

"PARK"
Theme

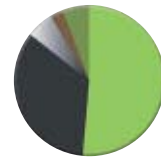

"URBAN 1"
Theme



"URBAN 2"
Theme

VERTIGO
7-14 years

Vertigo

JVX-0001



JVX-0001 presented in "URBAN 2"

Designation	Vertigo 1- Urban 2
Age group	7-14 years
Dimensions of equipment	(LxVxH in mm) 2507 x 646 x 3200
Minimum space requirements	(LxV in mm) 6638 x 4843
Total impact area	26,3
Activities	4

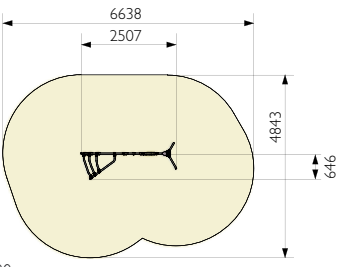

JVX-0002



VERTIGO
7-14 years



JVX-0002 presented in "URBAN 1"

Designation	Vertigo I- Urban I
Age group	7-14 years
Dimensions of equipment	(LxVxH in mm) 5783 x 5585 x 3200
Minimum space requirements	(LxW in mm) 8748 x 8527
Total impact area	47 m ²
Activities	5

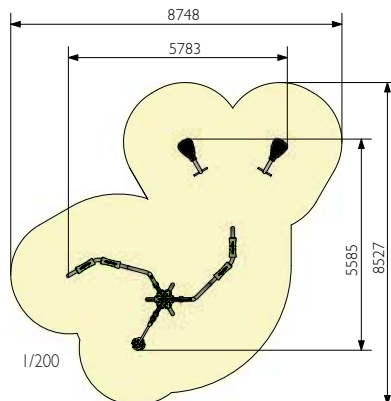

Vertigo

JVX-0003



JVX-0003 presented in "PARK"

Designation	Vertigo I- Park
Age group	7-14 years
Dimensions of equipment	(LxWxH in mm) 3130 x 2371 x 3400
Minimum space requirements	(LxW in mm) 6834 x 5619
Total impact area	29
Activities	5

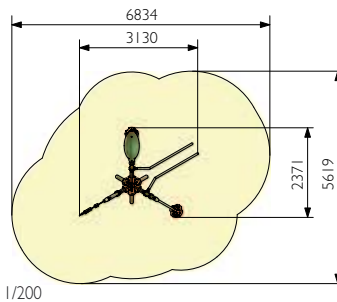

1/200





VERTIGO
7-14 years



JVX-0004 presented in "URBAN 1"

Designation	Vertigo 2 - Urban I
Age group	7-14 years
Dimensions of equipment	(LxWxH in mm) 4379 x 3214 x 3200
Minimum space requirements	(LxW in mm) 8462 x 7036
Total impact area	40,9 m ²
Activities	9

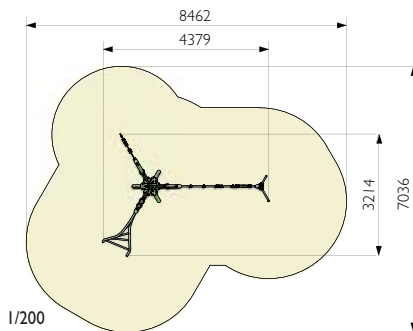

Vertigo

JVX-0005



JVX-0005 presented in "URBAN 2"

Designation	Vertigo 1 - Urban 2
Age group	7-14 years
Dimensions of equipment	(LxWxH in mm) 3460 x 3164 x 3200
Minimum space requirements	(LxW in mm) 7407 x 6641
Total impact area	33,8
Activities	4

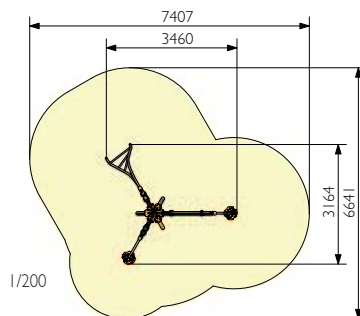

JVX-0006



VERTIGO
7-14 years



JVX-0006 presented in "PARK"

Designation	Vertigo 2 - Park
Age group	7-14 years
Dimensions of equipment	(LxWxH in mm) 6454 x 4885 x 3455
Minimum space requirements	(LxW in mm) 10424 x 8968
Total impact area	61,1 m ²
Activities	9

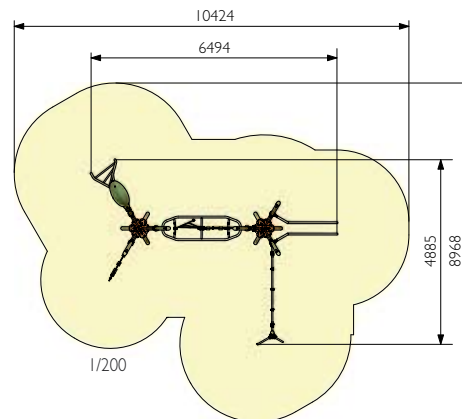

Vertigo

JVX-0007



JVX-0007 presented in "URBAN 2"

Designation	Vertigo 2 - Urban 2
Age group	7-14 years
Dimensions of equipment	(LxWxH in mm) 6494 x 4323 x 3200
Minimum space requirements	(LxW in mm) 10424 x 7891
Total impact area	53
Activities	6

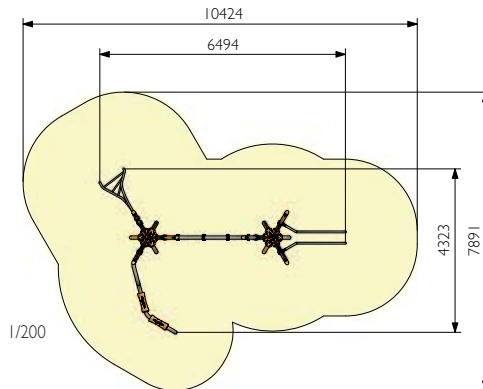

JVX-0008



VERTIGO
7-14 years



JVX-0008 presented in "PARK"

Designation	Vertigo 2 - Park
Age group	7-14 years
Dimensions of equipment	(LxWxH in mm) 8286 x 2838 x3400
Minimum space requirements	(LxW in mm) 12203 x 6088
Total impact area	57,8 m ²
Activities	7

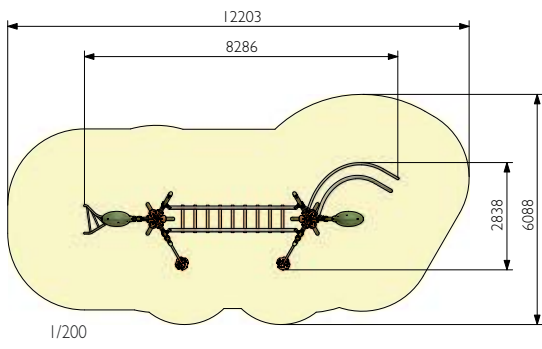

1/200



Vertigo

JVX-0009



JVX-0009 presented in "URBAN 1"

Designation	Vertigo 3 - Urban I
Age group	7-14 years
Dimensions of equipment	(LxWxH in mm) 5791 x 6249 x 3200
Minimum space requirements	(LxW in mm) 9660 x 9779
Total impact area	61,1
Activities	8

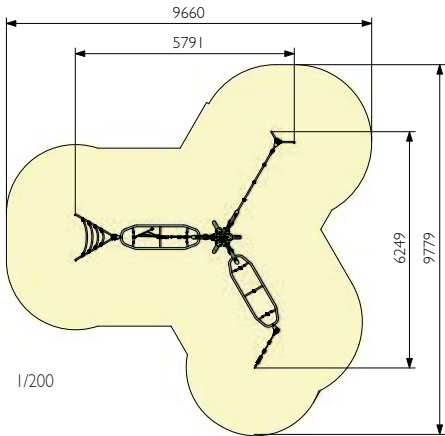

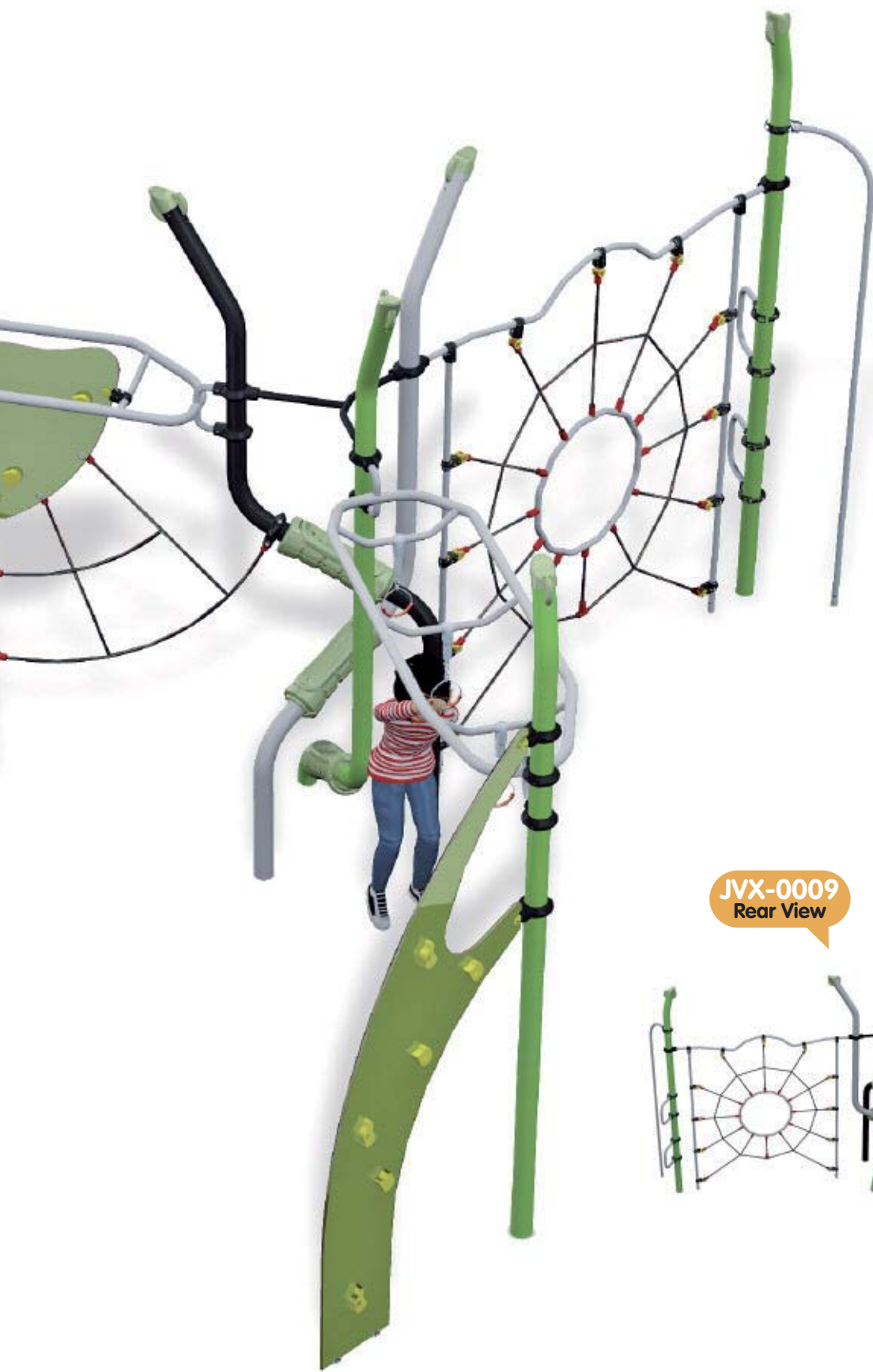

JvX-0009
Rear View



VERTIGO
7-14 years



Vertigo

JVX-0011

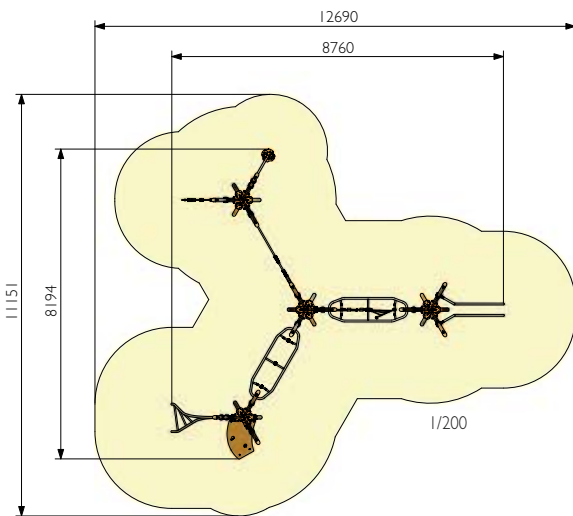
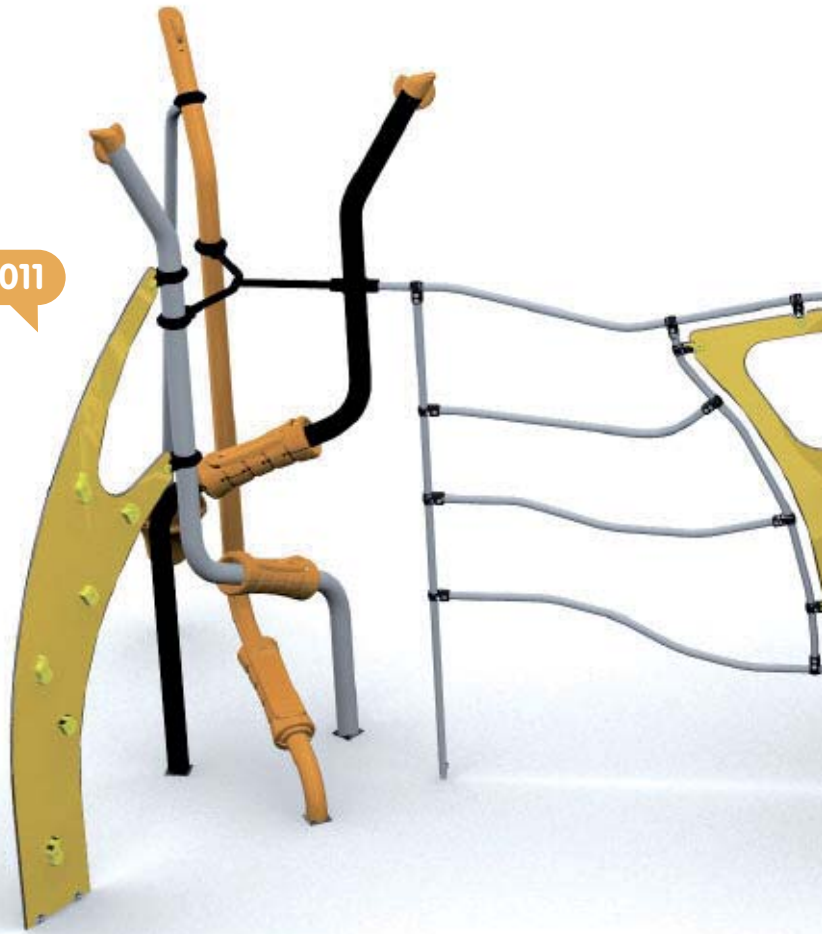

JVX-0011 presented in "URBAN 2"

Designation	Vertigo 4 - Urban 2
Age group	7-14 years
Dimensions of equipment	(LxWxH in mm) 8760 x 8194 x 3200
Minimum space requirements	(LxW in mm) 12690 x 11151
Total impact area	82,7
Activities	12





JvX-0011
Rear View



VERTIGO
7-14 years



Vertigo



JVX-0012
Rear View



JVX-0012 presented in "URBAN 1"

Designation	Vertigo 4 -Urban I
Age group	7-14 years
Dimensions of equipment	(LxWxH in mm) 13608 x 7797 x 3200
Minimum space requirements	(LxW in mm) 17529 x 11230
Total impact area	114,7
Activities	15



JVX-0012



VERTIGO
7-14 years

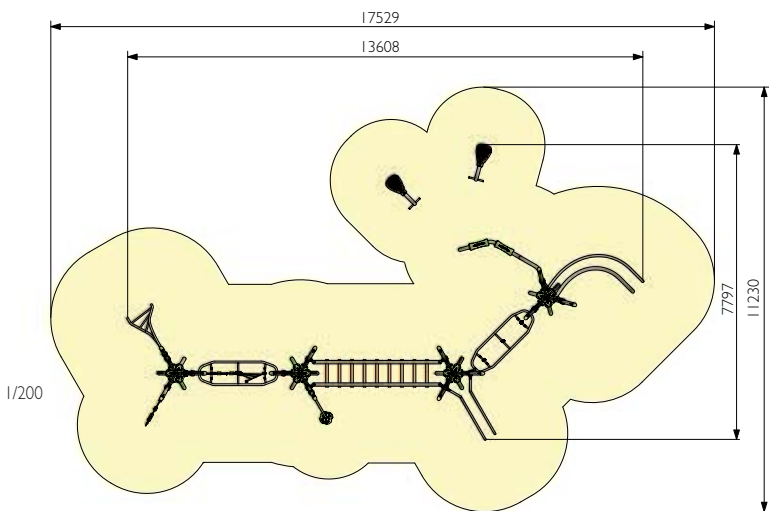



wonderfully appealing and brimming with ideas!

Super role-playing equipment where our adventure and wonder-loving children love to transform themselves into pilots, firemen or ... little pirates!

+ Ideas

Play equipment designed for **2 to 8 year olds**.
Compact, yet comprehensive play equipment for installing equipment in small areas whilst offering children a maximum number of play activities at the same time.

+ Design

A highly original design for attracting big and small alike!

+ Fun: Dream vehicles!

Themed play equipment for stimulating the imagination.

The themes on offer clearly evoke the different vehicles (Jeep, plane, roadster, tractor, train, campervan, boat, etc.) which children really love.

Physical play equipment for encouraging sports activities!

Children love clambering and climbing. Even the smallest children possess remarkable motor skills, which must be encouraged.

Every **MAGIC'COLOR** vehicle is equipped with at least one climbing activity.

Play equipment that provides thrills to help their confidence grow!

It is because children love thrills and the fun of slipping and sliding that slides have not been forgotten.

Play equipment for encouraging children to play together!

The new **MAGIC'COLOR** items of play equipment possess a magical power that encourages children to play together ... at being super-heroes for example.





MAGIC'COLOR
2-8 years





The Technical +



1- A unique concept*:

- Compact play equipment delivered ready assembled (assembled by technicians at the factory), for ultra-rapid trouble-free installation.

2- An exclusive assembly system*:

- Clamps and balls made in injected die cast aluminium
- Special "one tool fits all", vandal-proof fasteners (exclusive to HUSSON for maximum vandal resistance).

3- Quality in the smallest detail:

- An extremely robust stainless steel framework
- Panels in multicoloured HPL, specially designed for HUSSON: Solid high-pressure laminate, highly resistant (15 mm thick), rot-resistant, with low-flammability levels and colour-through material.
- Components are moulded in extra-thick HDPE (High Density Polyethylene) for maximum toughness. This material is colour-through and requires minimal maintenance.

4- Safety:

- **MAGIC'COLOR** play equipment is designed to meet the new European EN 1176 standards, version 2008.
- Pushing concern for safety to the highest possible levels, **MAGIC'COLOR** play equipment is often ahead of standards and regulations in force, especially concerning its solidity.

5- A 10-year guarantee:

- Parts guaranteed: Stainless steel structure, metal and HPL components
- For the terms and conditions of HUSSON guarantees: please refer to HUSSON's general conditions of sale (on the back pages of the current price list).

6- Minimal maintenance:

- Use stainless steel and a unique multi-D+ assembly system* (common across all the HUSSON ranges) is the solution for a minimal, low cost maintenance routine ensuring that your play equipment is safe to use for many years to come.

7- Encouraging sustainable development:

- All materials used are ecologically inert, i.e. they remain environment-friendly throughout their service life and can then be easily recycled, as is the case for stainless steel.
- HUSSON play equipment is renowned for its long life, another crucial aspect of sustainable development!

*Patented systems, registered designs



MAGIC'COLOR
2-8 years





The Campervan

"Holidays for ever!"



JMA-0523

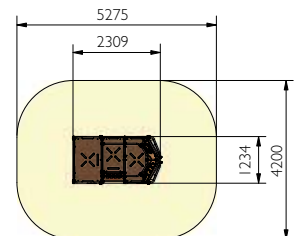

JMA-0522

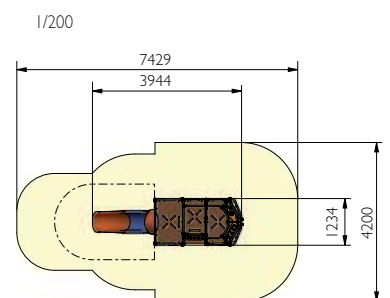



MAGIC'COLOR
2-8 years



JMA-0523

JMA-0522

Name	The Campervan	The Campervan-Slide
Recommended age groups	2-5 years	2-5 years
Dimensions of equipment	(LxWxH in mm) 2309 x 1234 x 1695	(LxWxH in mm) 3944 x 1234 x 1695
Minimum surface required	(LxW in mm) 5275 x 4200	(LxW in mm) 7429 x 4200
Total zone of impact	20,2 m ²	25,2 m ²
Activities	9	10



hiding



sheltering



going up



climbing



crossing



sliding



balancing



Interaction



role-playing



hands-on activities

Activities
JMA-0522

JMA522



www.husson.eu

141



The Roadster

"Back to the future!"



JMA-0520





MAGIC'COLOR
2-8 years



JMA-0520

Name	The Roadster
Recommended age groups	2-5 years
Dimensions of equipment	(LxVxH in mm) 3158 x 1480 x 1200
Minimum surface required	(LxV in mm) 6116 x 4480
Total zone of impact	25,5 m ²
Activities	9

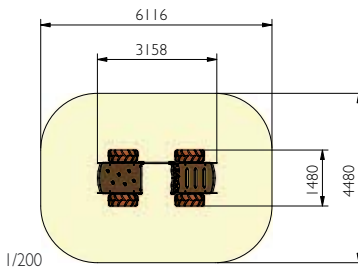

Optional wheel games:
Working gears and cogs or ball and maze game.



Play equipment accessible to ALL





The Rally Raid

"Watch out!
Here we come!"



JMA-0521





MAGIC'COLOR
2-8 years



JMA-0521

Name	The Rallye Raid
Recommended age groups	2-5 years
Dimensions of equipment	(LxVxH in mm) 4561 x 1886 x 1605
Minimum surface required	(LxV in mm) 8062 x 4884
Total zone of impact	31,8 m ²
Activities	10

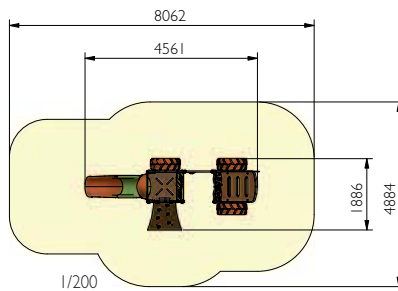

Optional wheel games:
Working gears and cogs or
ball and maze game.

- hiding
- sheltering
- going up
- climbing
- crossing
- sliding
- balancing
- Interaction
- role-playing
- hands-on activities



Play equipment
accessible to ALL



The Jeep

“Ready for the adventure?”

JMA-0524

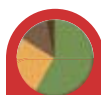

JMA-0524

Name	The Jeep
Recommended age groups	2-5 years
Dimensions of equipment	(LxVxH in mm) 3158 x 1480 x 1200
Minimum surface required	(LxV in mm) 6116 x 4480
Total zone of impact	25,5 m ²
Activities	7

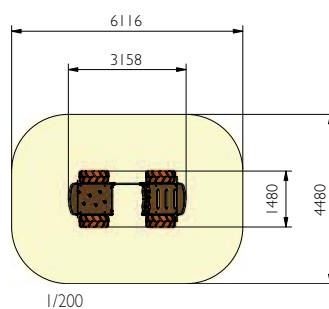

hiding



sheltering



going up



climbing



crossing



sliding



balancing



Interaction



role-playing



hands-on activities



Play equipment accessible to ALL



JMA-0525

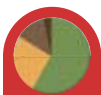

JMA-0525

Name	The Jeep-Side
Recommended age groups	2-5 years
Dimensions of equipment	(LxVxH in mm) 4561 x 1886 x 1605
Minimum surface required	(LxV in mm) 8062 x 4884
Total zone of impact	31,8 m ²
Activities	10

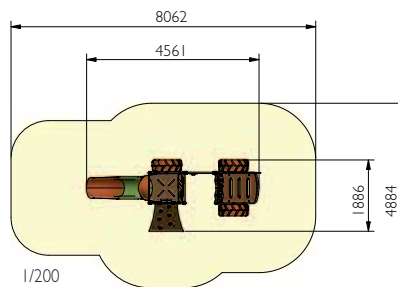

Optional wheel games:
Working gears and cogs or
ball and maze game.

- hiding
- sheltering
- going up
- climbing
- crossing
- sliding
- balancing
- Interaction
- role-playing
- hands-on activities



Play equipment
accessible to ALL

MAGIC'COLOR
2-8 years





The Pick-up

"We're the explorers!"



JMA-0508

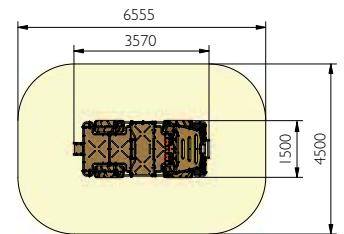

JMA-0503

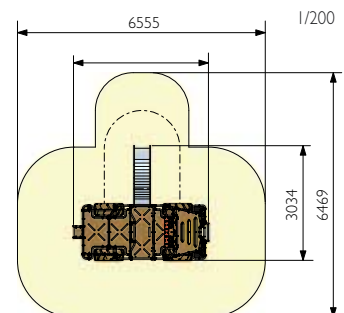
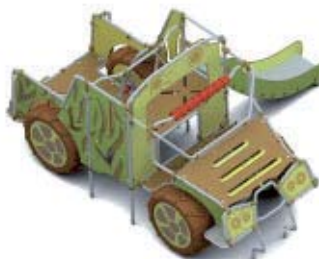



MAGIC'COLOR
2-8 years

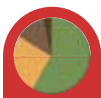

JMA-0508

JMA-0503

Name	The Pick-up	The Pick-up-Slide
Recommended age groups	2-8 years	2-8 years
Dimensions of equipment	(LxWxH in mm) 3570 x 1500 x 1900	(LxWxH in mm) 3570 x 3034 x 1900
Minimum surface required	(LxW in mm) 6555 x 4500	(LxW in mm) 6555 x 6469
Total zone of impact	27,6 m ²	32 m ²
Activities	12	13

Optional wheel games:
Working gears and cogs or
ball and maze game.



hiding



sheltering



going up



climbing



crossing



sliding



balancing



Interaction



role-playing



hands-on activities

Activities
JMA-0503





The plane

"We're the kings of the skies!"



JMA-0509

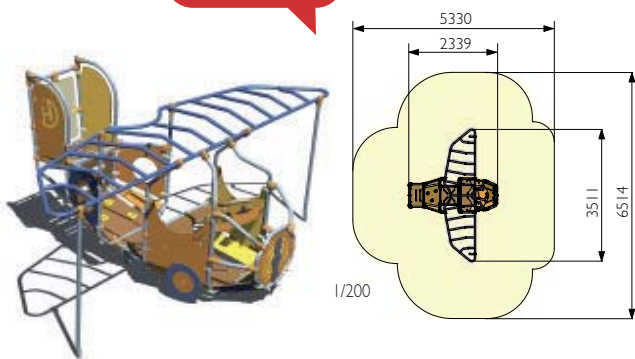

JMA-0501

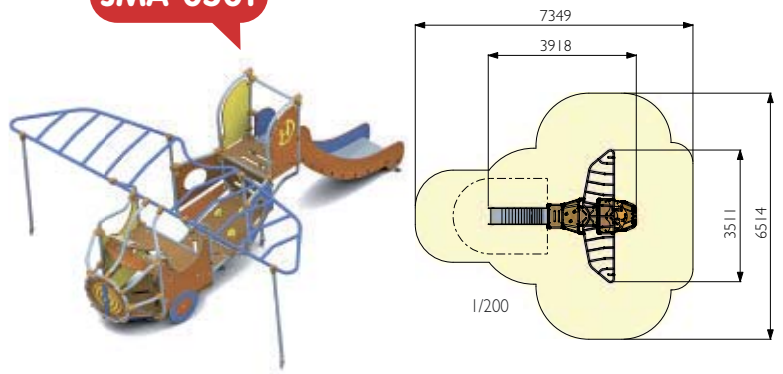



MAGIC'COLOR
2-8 years



JMA-0509

JMA-0501

Name	The Plane	The Plane-Silde
Recommended age groups	3-10 years	3-10 years
Dimensions of equipment	(LxWxH in mm) 2339 x 3511 x 1800	(LxWxH in mm) 3918 x 3511 x 1800
Minimum surface required	(LxW in mm) 5330 x 6514	(LxW in mm) 7349 x 6514
Total zone of impact	27,6 m ²	32,3 m ²
Activities	9	10



hiding



sheltering



going up



climbing



crossing



sliding



balancing



Interaction



role-playing



hands-on activities

Activities
JMA-0501





The Fire Engine

"Always ready for another mission!"



JMA-0527

JMA-0526

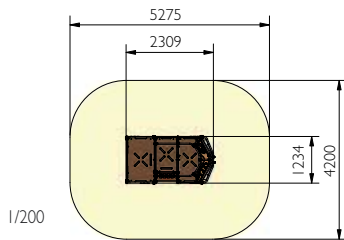

JMA-0527

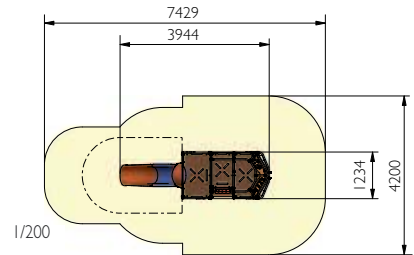



MAGIC'COLOR
2-8 years



JMA-0526

JMA-0527

Name	The Fire Engine	The Fire Engine-Slide
Recommended age groups	2-5 years	2-5 years
Dimensions of equipment	(LxWxH in mm) 2309 x 1234 x 1695	(LxWxH in mm) 3944 x 1234 x 1695
Minimum surface required	(LxW in mm) 5275 x 4200	(LxW in mm) 7429 x 4200
Total zone of impact	20,2 m ²	25,2 m ²
Activities	9	10



hiding



sheltering



going up



climbing



crossing



sliding



balancing



Interaction



role-playing



hands-on activities

Activities
JMA-0527

JMA527



www.husson.eu

153



The Tractor

“Everyone on board super-tractor!”

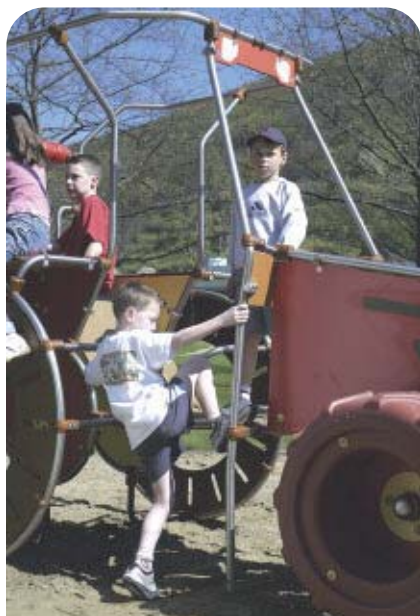

JMA-0502





MAGIC'COLOR
2-8 years



JMA-0502

Name	The Tractor
Recommended age groups	3-10 years
Dimensions of equipment	(LxVxH in mm) 4517 x 1564 x 2200
Minimum surface required	(LxW in mm) 7492 x 4564
Total zone of impact	29,8 m ²
Activities	13

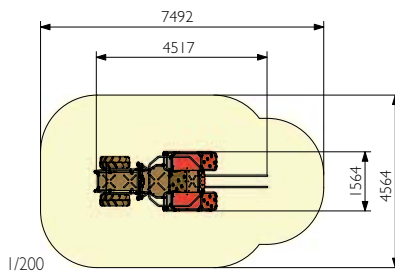

hiding



sheltering



going up



climbing



crossing



sliding



balancing



Interaction



role-playing



hands-on activities

JMA502



www.husson.eu

155



The Boat

"Ship Ahoy!"



JMA-0510

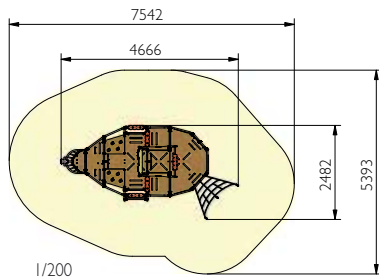

JMA-0500

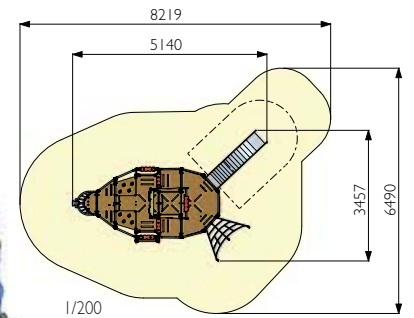



MAGIC'COLOR
2-8 years



JMA-0510

JMA-0500

Name	The Boat	The Boat-Slide
Recommended age groups	2-8 years	2-8 years
Dimensions of equipment	(LxWxH in mm) 4666 x 2482 x 2950	(LxWxH in mm) 5140 x 3457 x 2950
Minimum surface required	(LxW in mm) 7542 x 5393	(LxW in mm) 8219 x 6490
Total zone of impact	30 m ²	35,4 m ²
Activities	16	17

-  1 hiding
-  1 sheltering
-  2 going up
-  3 climbing
-  1 crossing
-  1 sliding
-  1 balancing
-  1 Interaction
-  1 role-playing
-  5 hands-on activities

Activities
JMA-0500





The Ship Wreck

“Discover sunken treasure!”

JMA-0516

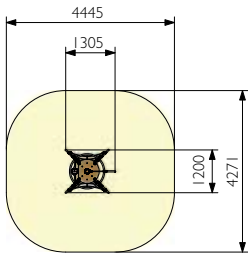

1/200

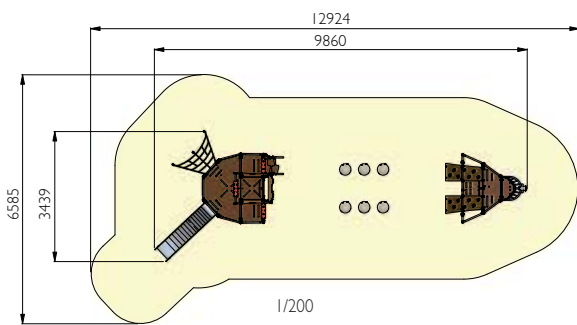

1/200

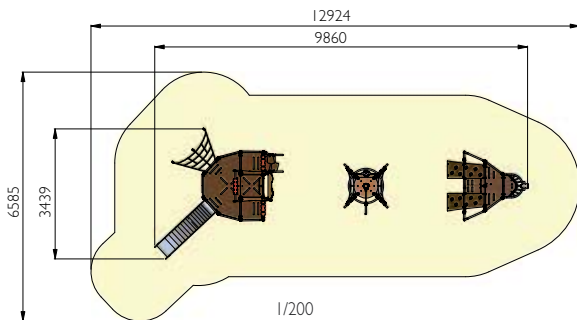

1/200



JMA-0515



JMA-0511





MAGIC'COLOR
2-8 years



JMA-0516

JMA-0515

JMA-0511

Name	The Look-Out Post	The Boat-Blocks	The Lying Boat
Recommended age group	3-10 years	2-8 years	3-10 years
Dimensions of equipment	(LxWxH in mm) 1305 x 1200 x 3945	(LxWxH in mm) 9806 x 3457 x 3000	(LxWxH in mm) 9860 x 3439 x 3945
Minimum surface required	(LxW in mm) 4445 x 4271	(LxW in mm) 12870 x 6585	(LxW in mm) 12924 x 6585
Total zone of impact	16,8 m ²	58,3 m ²	58,5 m ²
Activities	6	17	20



hiding



sheltering



going up



climbing



crossing



sliding



balancing



Interaction



role-playing



hands-on activities

Activities
JMA-0511





The Little Train

"All aboard for the Fun Express!"



JMA-0448

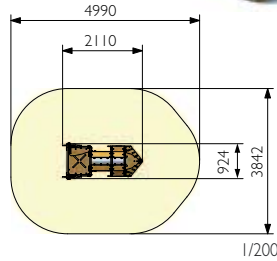

JMA-0473

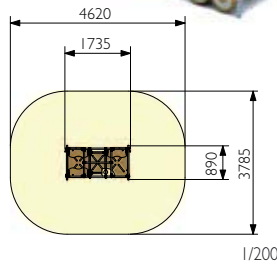

JMA-0487

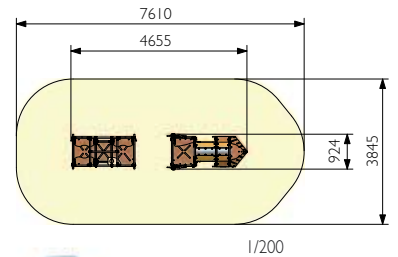
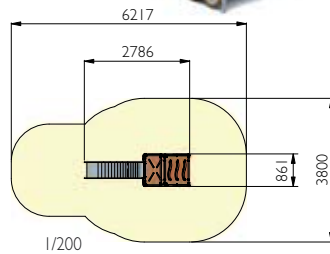

JMA-0505





MAGIC'COLOR
2-8 years



	JMA-0448	JMA-0473	JMA-0487	JMA-0505
Name	The Locomotive	The Wagon for Passengers	The Slide-Wagon	The Small Train
Recommended age groups	2-5 years	2-5 years	2-5 years	2-5 years
Dimensions of equipment	(LxWxH in mm) 2110 x 924 x 1400	1735 x 890 x 1516	2786 x 861 x 1805	4655 x 924 x 1516
Minimum surface required	(LxW in mm) 4990 x 3842	4620 x 3785	6217 x 3800	7610 x 3845
Total zone of impact	16,5 m ²	15,6 m ²	18,9 m ²	26,5 m ²
Activities	7	6	8	9



hiding



sheltering



going up



climbing



crossing



sliding



balancing



Interaction



role-playing



hands-on activities

Activities
JMA-0505





The Big Train

"Travelling 1st class!"





MAGIC'COLOR
2-8 years



JMA-0504

Name	The Big Train
Recommended age groups	2-5 years
Dimensions of equipment	(LxVxH in mm) 8883 x 924 x 1805
Minimum surface required	(LxW in mm) 12328 x 3842
Total zone of impact	41,8 m ²
Activities	13

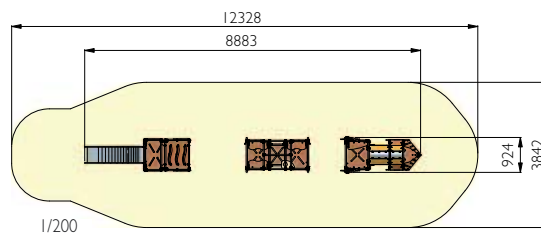

hiding



sheltering



going up



climbing



crossing



sliding



balancing



Interaction



role-playing



hands-on activities

JMA504



www.husson.eu

163

SOLO+

Essential play equipment!

Installed by themselves or
together with multiplay units,
HUSSON independent play units
add a large + to playgrounds.

+ Ideas

Husson International proposes a wide range of independent play units suited to different user groups:

For 2 year olds and over

Play equipment with springs, seesaws, roundabouts, slides, maisonette play houses, mini furniture, etc.

For 7 year olds and over

Climbing play equipment (Pyramids and Rope Dome), concrete table tennis and table football tables, dynamic play equipment (Gigoto, Skywalker, Skate-training, etc.), the Telerally...

For all

Shelters, flooring and safety kerbs, fencing, information boards, etc.

+ Design

With the **SOLO+** range and its almost 100 different independent play units, you can create original playgrounds without any limits. Colours have been chosen to match the themes for the **PICCOLO**, **CAMELEO**, **VERTIGO** multifunction structures.

+ Fun

SOLO+ play units carry children away towards essential, stimulating and highly varied activities.



For 2 year olds and over



For 7 year olds and over

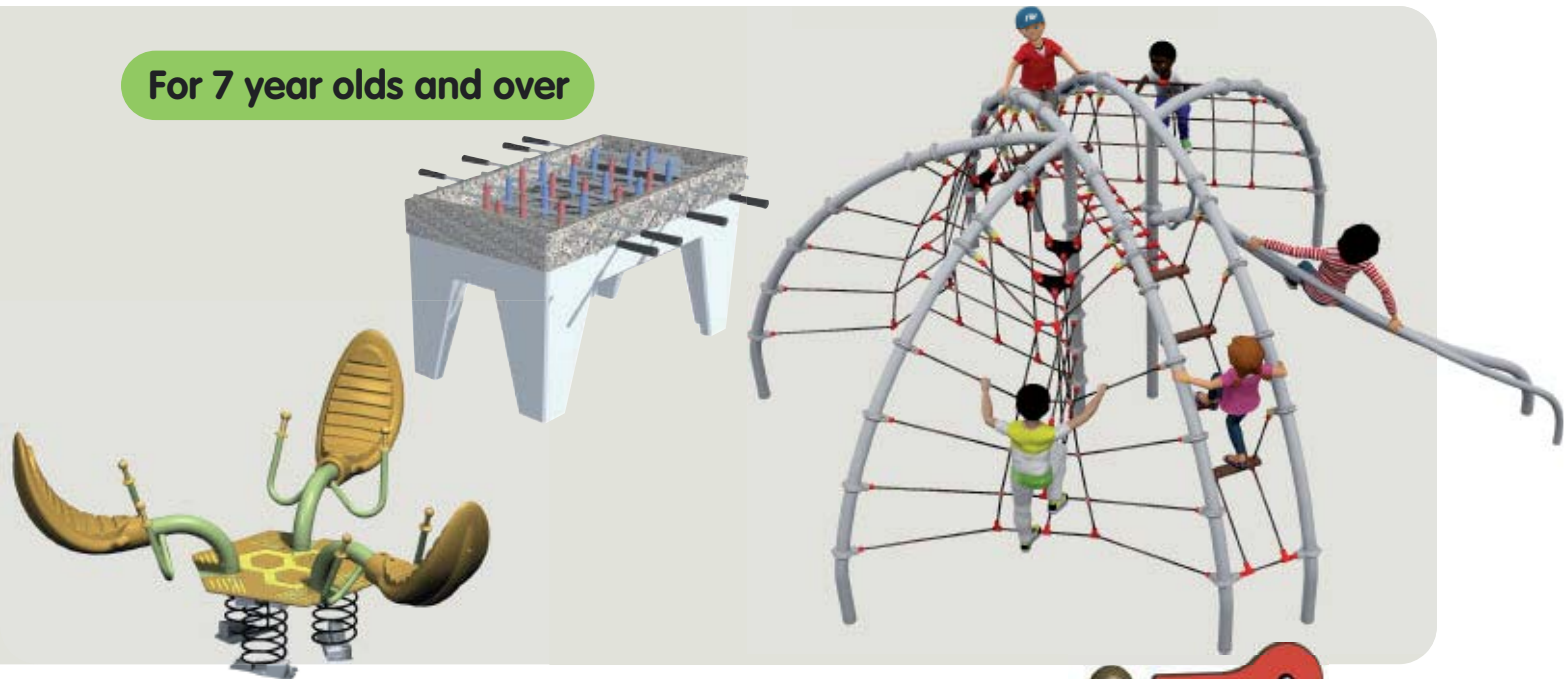

For ALL

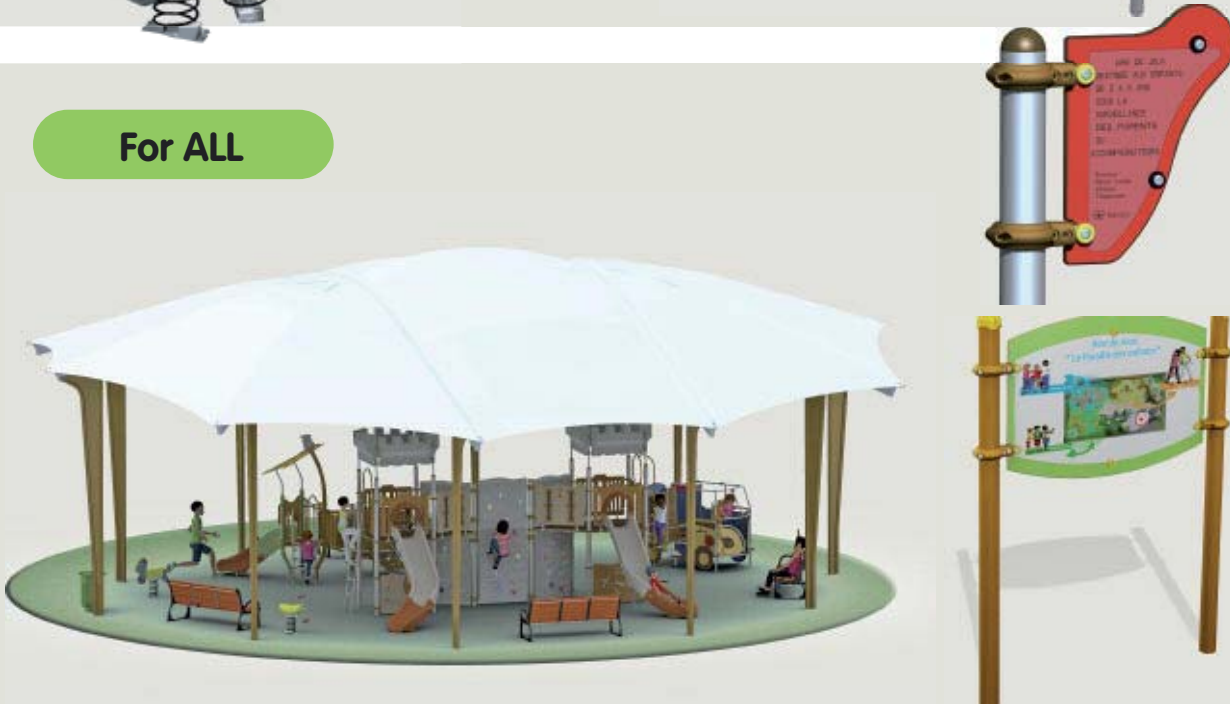

+ OTOS



Super Springers for releasing all their energy

Springers, installed as a solo item or as an extra for multifunctional structures are always appreciated by children.

+ Ideas

Play equipment designed for **2 to 8 year olds**. Models with a double side protection, a wide seat and a footrest offer comfort and safety to toddlers.

+ Design

Shapes and colours have been chosen to match the themes for the **PICCOLO, CAMELEO, VERTIGO** multifunction structures and make it easy to integrate equipment harmoniously in all environments.

+ Fun

Springers, developed on several themes (vehicles, animals, etc.), carry children away on imaginary trips and plunge them into exciting adventures!

+ Technical

An anti-trapping system ① :

The anti-trapping system comprised of 2 fixing parts in die cast aluminium is specially designed for eliminating any danger of trapping fingers or other protruding parts

Safety:

HUSSON Springers are designed to the new European EN 1176 standards, version 2008.

Quality materials ② :

Robust springs designed for intensive use remain sufficiently flexible for toddlers to be able to swing or bounce.

The themed panels are made in HDPE (High Density Polyethylene), in colour-through material, easy to service and they can be completely recycled.

Seats are rotation-moulded, with supports in stainless steel sheet.

The stainless steel fasteners are vandal-proof (with the HUSSON proprietary tool) ④

Anchoring base ③ :

A practical, efficient anchoring system that enables the base simply to be buried in a hole 600 x 600 x 550 mm (without concrete).

As an option, a "Zero level fixing system" is available (fixed onto a concrete slab).



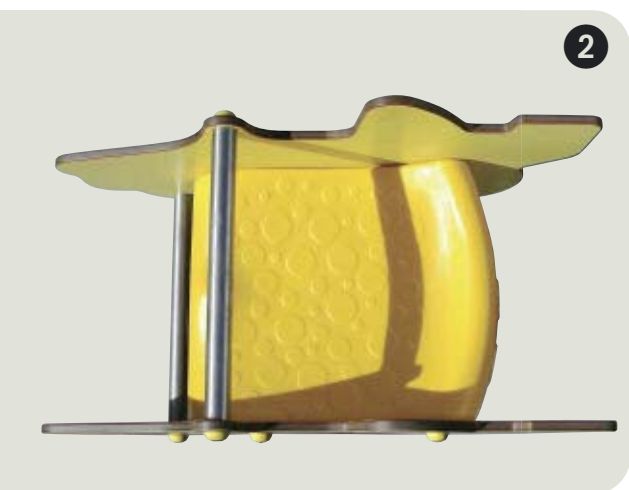

+ OTOS

SOLO+

Springers



JIN-0529 Elephant



JIN-0528 Horse



JIN-0525 Hippo



JIN-0526 Seal

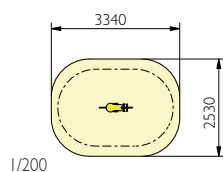

	JIN-0529	JIN-0528	JIN-0525	JIN-0526
Designation	Elephant	Horse	Hippo	Seal
Age group	2-8 years	2-8 years	2-8 years	2-8 years
Dimensions of equipment (LxWxH in mm)	872 x 238 x 791	853 x 238 x 830	857 x 238 x 810	943 x 238 x 809
Minimum space requirements (LxW in mm)	3340 x 2530	3340 x 2530	3340 x 2530	3340 x 2530
Total impact area	7,6 m ²	7,6 m ²	7,6 m ²	7,6 m ²





JIN-0523 Dog



JIN-0393 Motorbike



JIN-0527 Witch



JIN-0524 Dino

	JIN-0523	JIN-0393	JIN-0527	JIN-0524
Designation	Dog	Motorbike	Witch	Dino
Age group	2-8 years	2-8 years	2-8 years	2-8 years
Dimensions of equipment	(LxWxH in mm) 825 x 238 x 820	845 x 238 x 780	929 x 238 x 857	899 x 238 x 822
Minimum space requirements	(LxW in mm) 3340 x 2530	3340 x 2530	3340 x 2530	3340 x 2530
Total impact area	7,6 m ²	7,6 m ²	7,6 m ²	7,6 m ²

SOLO +



SOLO+

Springers



JIN-0397 Car



JIN-0400 Ladybird



JIN-0403 Covered Wagon

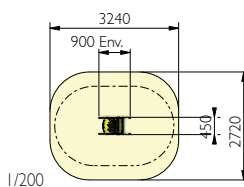

JIN-0405 Pram

	JIN-0397	JIN-0400	JIN-0403	JIN-0405
Designation	Car	Ladybird	Covered Wagon	Pram
Age group	2-5 years	2-5 years	2-5 years	2-5 years
Dimensions of equipment (LxWxH in mm)	677 x 420 x 693	636 x 413 x 689	538 x 416 x 685	578 x 416 x 726
Minimum space requirements (LxW in mm)	3240 x 2720	3240 x 2720	3240 x 2720	3240 x 2720
Total impact area	8 m ²	8 m ²	8 m ²	8 m ²





JIN-0394 FI NR1



JIN-0398 Helico



JIN-0399 Jet Ski

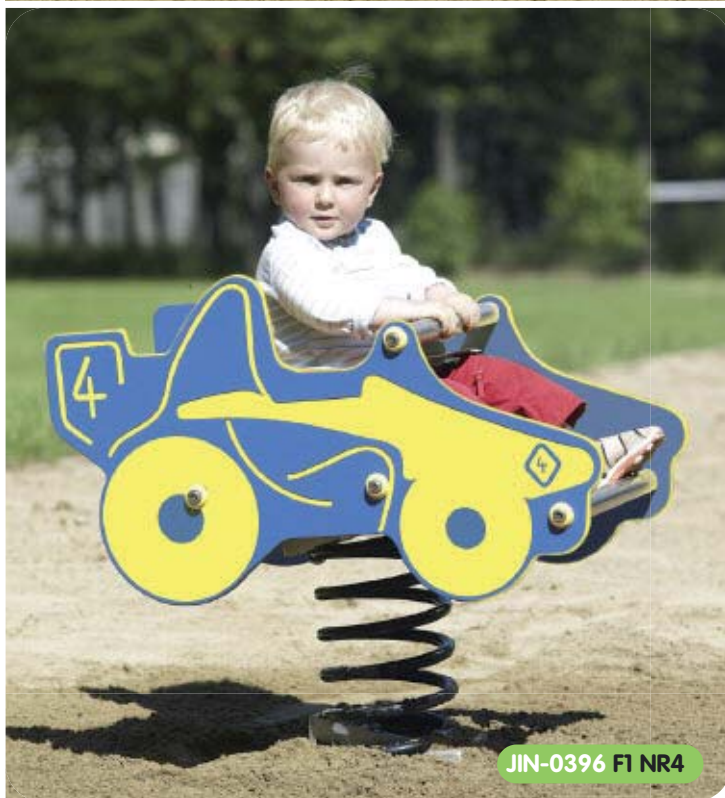

JIN-0396 FI NR4

	JIN-0394	JIN-0398	JIN-0399	JIN-0396
Designation	FI NR1	Helico	Jet Ski	FI NR4
Age group	2-5 years	2-5 years	2-5 years	2-5 years
Dimensions of equipment	(LxWxH in mm) 789 x 416 x 729	723 x 416 x 759	675 x 416 x 706	789 x 416 x 729
Minimum space requirements	(LxW in mm) 3240 x 2720	3240 x 2720	3240 x 2720	3240 x 2720
Total impact area	8 m ²	8 m ²	8 m ²	8 m ²

+ OTOS



SOLO+

Springers



JIN-0048 Clover

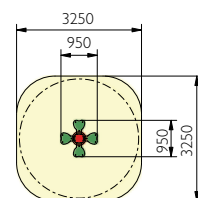

1/200



JIN-0378 Side Car

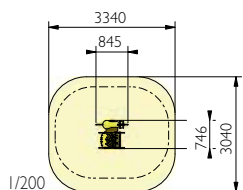

1/200

	JIN-0048	JIN-0378
Designation	Clover 4 Places	Side Car
Age group	3-8 years	2-8 years
Dimensions of equipment	(LxWxH in mm) 950 x 950 x 600	845 x 746 x 802
Minimum space requirements	(LxW in mm) 3250 x 3250	3340 x 3040
Total impact area	9.7 m ²	9.3 m ²





JIN-0401 Flower



JIN-0395 FI NR5



JIN-0404 Catapult



JIN-0402 Moon

	JIN-0401	JIN-0395	JIN-0404	JIN-0402
Designation	Flower	FI NR5	Catapult	Moon
Age group	2-5 years	2-5 years	2-5 years	2-5 years
Dimensions of equipment (LxWxH in mm)	690 x 416 x 717	789 x 416 x 729	723 x 416 x 759	668 x 416 x 856
Minimum space requirements (LxW in mm)	3240 x 2720	3240 x 2720	3240 x 2720	3240 x 2720
Total impact area	8 m ²	8 m ²	8 m ²	8 m ²

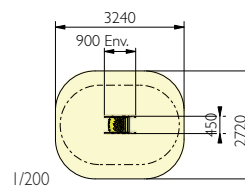

SOLO +



SOLO+

Springers

Single and double
with metal mounting
brackets



JIN-0530 Metal Springer 1 Place

JIN-0530

Designation	Metal Springer 1 Place
Age group	2-8 years
Dimensions of equipment	(LxVxH in mm) 597 x 320 x 803
Minimum space requirements	(LxV in mm) 3340 x 2530
Total impact area	7,6 m ²

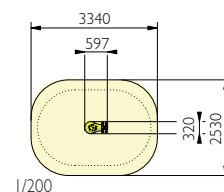



JIN-0531 Metal Springer 2 Place

JIN-0531

Designation	Metal Springer 2 Place
Age group	2-8 years
Dimensions of equipment	(LxWxH in mm) 1410 x 414 x 824
Minimum space requirements	(LxW in mm) 4409 x 2714
Total impact area	11,1 m ²



+ OTOS





JIN-0413 "1-Way" Seesaw



JIN-0413

Designation	"1-Way" Seesaw
Age group	2-8 years
Dimensions of equipment	(LxWxH in mm) 2686 x 405 x 757
Minimum space requirements	(LxW in mm) 4686 x 3414
Total impact area	14 m ²

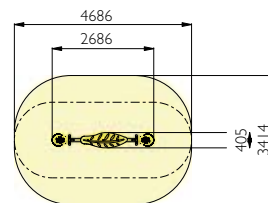

1/200





JIN-0414 "3-Way" Seesaw



JIN-0414

Designation	"3-Way" Seesaw
Age group	2-8 years
Dimensions of equipment	(LxWxH in mm) 2094 x 2369 x 757
Minimum space requirements	(LxW in mm) 4263 x 4459
Total impact area	14,6 m ²

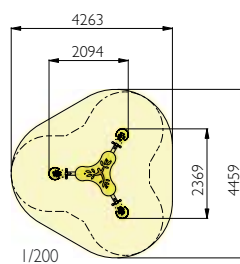

SOLO +



Pegasus rocking horse

+ Ideas

Play equipment designed for **2 to 8 year olds**. Pegasus is like the well-known rocking horse, but adapted for intensive collective use.

+ Design

Inspired by the world of Cartoons, shapes favour ergonomics and have reassuring rounded forms.

+ Fun

By themselves or with a friend, children can enjoy the gently rocking motion thanks to an exclusive mechanism.

+ Technical

- The body of the horse is made with rotation moulding technology in extra-thick HDPE (High Density Polyethylene) for maximum toughness. This material is colour-through and requires minimal maintenance.
- Mechanism
 - An ingenious mechanism giving gentle, regular movements irrespective of the child's weight.
 - A unit designed for intensive use and easy maintenance.
 - Mechanisms (fitted with an anti-finger-catching device) are housed inside the horse's body for maximum safety. A hatch is provided under the saddle for easy maintenance.
 - Support assembly and mechanism in double surface-treated steel
- Equipment in conformity with the new European EN 1176 standard, version 2008.



JIN-0483

Designation	Pegasus rocking horse 2 places
Age group	2-8 years
Dimensions of equipment	(LxWxH in mm) 1019 x 400 x 1020
Minimum space requirements	(LxW in mm) 3235 x 2400
Total impact area	6,9 m ²

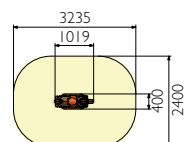

1/200





Pegasus on spring

+ Ideas

Play equipment designed for **3 to 10 year olds.**

+ technical

Features identical to the **Pegasus rocking horse** unit (JIN-0483) except for the rocking system. **The Pegasus on springs** (JIN-0543) is equipped with 2 robust springs as per the "Play units on springs" technical description on page 166.



JIN-0543

Designation	Pegasus on springs 2 places
Age group	3-10 years
Dimensions of equipment	(LxWxH in mm) 1019 x 400 x 1145
Minimum space requirements	(LxW in mm) 3550 x 2400
Total impact area	7,7 m ²

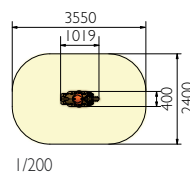

SOLO +



The floating island

+ Ideas

Play equipment designed for **3 to 8 year olds**. The floating island is collective fantasy piece of play equipment designed to enable up to 6 children to play together in complete safety.

+ Design

Ergonomics have received special treatment. The rounded shapes and floor surface are made non-slip by means of attractive patterns.

+ Fun

Standing up or sitting down, 1 to 6 children have to shake the coconut tree together!

+ Technical

- Framework in galvanised and stainless steel.
- The shell is made using rotation moulding technology in extra-thick HDPE (High Density Polyethylene) for maximum toughness. This material is colour-through and requires minimum maintenance. RAL 6025 green paintwork.
- Rocking and damping system controlled by 3 powerful metal springs.
- Equipment in compliance with the new European EN 1176 standard, version 2008.



JIN-0415	
Designation	Floating island
Age group	3-8 years
Dimensions of equipment	(LxWxH in mm) 1600 x 1600 x 2050
Minimum space requirements	(LxW in mm) 4600 x 4600
Total impact area	16.7 m ²

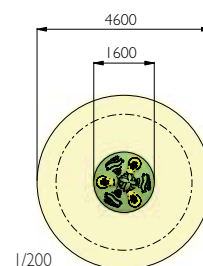



The spinning-top roundabout

+ Ideas

Play equipment designed for **2 to 8 year olds**.

+ Design

Ergonomics and safety pushed to their utmost limits. The central mechanism is fully protected.

For total safety, shapes are rounded and children are encouraged to push the roundabout using the handles on the back of the three saddles.

+ Fun

Roundabouts are undoubtedly one of children's favourite games, as they love sharing the thrills of a few fast turns.

+ Technical

- Framework in galvanised and stainless steel
- The shell is made using rotation moulding technology in extra-thick HDPE (High Density Polyethylene) for maximum toughness. This material is colour-through and requires minimal maintenance. RAL 6025 green paintwork
- An entirely protected mechanism comprising a central drum with sealed ball bearings.
- Equipment in compliance with the new European EN 1176 standard, version 2008.



JIN-0416	
Designation	Spinning-top roundabout
Age group	2-8 years
Dimensions of equipment	(LxVxH in mm) 1600 x 1600 x 1163
Minimum space requirements	(LxV in mm) 5600 x 5600
Total impact area	25 m ²

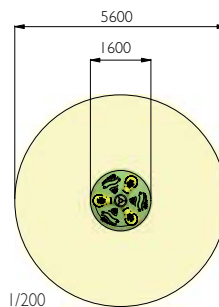

The Dizzy roundabout

+ Ideas

Play equipment designed for **2 to 8 year olds**.

+ Design

Ergonomics and safety pushed to their utmost limits. The central mechanism is fully protected

For total safety, shapes are rounded and children are encouraged to push the roundabout using the three handrails.

+ Fun

Toddlers calmly take their first lessons in roundabout games.

+ Technical

- Framework in galvanised and stainless steel.
- Turntable with non-slip steel plate.
- An entirely protected mechanism comprising a central drum with sealed ball bearings.
- Equipment in compliance with the new European EN 1176 standard, version 2008.





JIN-0532

Designation	Dizzy roundabout
Age group	2-8 years
Dimensions of equipment	(LxWxH in mm) 1196 x 1196 x 1246
Minimum space requirements	(LxW in mm) 5196 x 5196
Total impact area	21,2 m ²

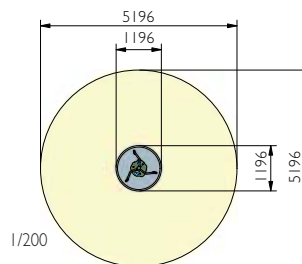

“New Wave” and “Birds’ nest” swings

+ Ideas

Play equipment designed for **2 to 8 year olds**.

+ Design

Original, gentle, rounded shapes similar to the movement of the waves and which make it easy to integrate the unit naturally into the landscape.

+ Fun

Children, both big and small love the unique swinging sensation.

+ Technical

- Frame work in hot-galvanized, powder-coated steel.
- New anti-wrap system to prevent the chains wrapping round the horizontal beam (“New Wave” model).
- Options: Special seats for toddlers and disabled children.
- A robust basket for several persons with a protective system around the outer metal rim (“Birds Nest” model)
- Equipment in conformity with the new European EN 1176 standard, version. 2008.

JJM-1126	
Designation	The “New Wave” Swings
Age group	2-8 years
Dimensions of equipment	(LxWxH in mm) 2162 x 4095 x 2400
Minimum space requirements	(LxW in mm) 6900 x 4255
Total impact area	29,4 m ²

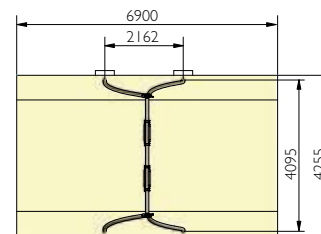

1/200



JJM-1127	
Designation	“Birds’ nest” Swings
Age group	2-8 years
Dimensions of equipment	(LxWxH in mm) 2162 x 4095 x 2400
Minimum space requirements	(LxW in mm) 6720 x 4255
Total impact area	28,6 m ²

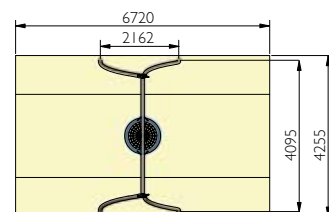

1/200





+ OTOS



Traditional slides

+ Ideas

Play equipment designed for **3 to 10 year olds**.
 HUSSON has chosen an all-steel solution for long life and easy maintenance.

+ Design

Traditional reassuring shapes;

+ Fun

Slides have always been playground favourites;

+ Technical

- Frame work in hot-galvanized, powder-coated steel RAL 6025 green paintwork
- Stainless steel sliding surface.
- Equipment in conformity with the new European EN 1176 standard, version 2008.

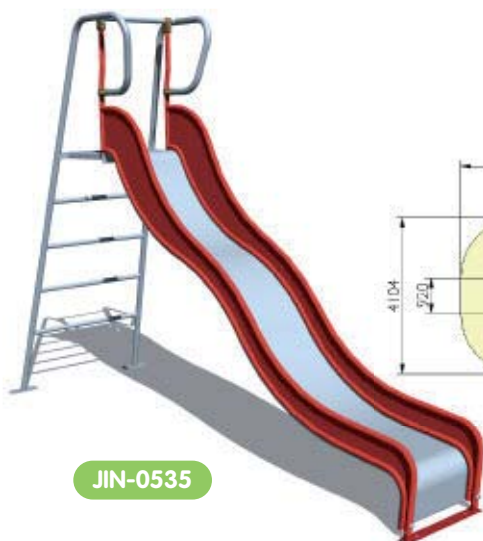

JIN-0535

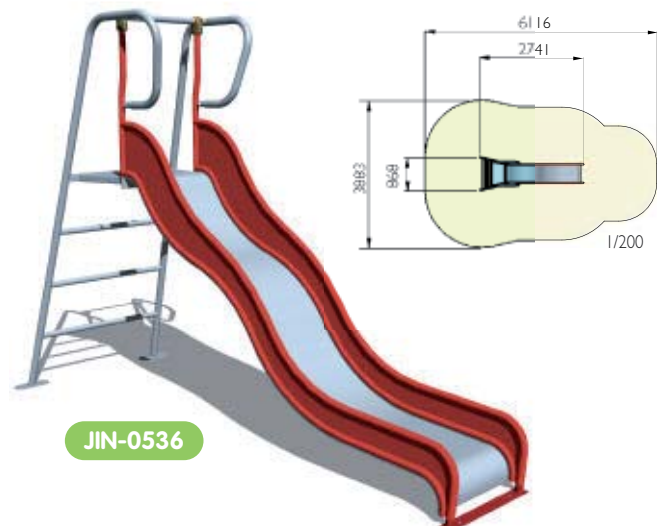

JIN-0536





JIN-0535 Slide 1,60 m

	JIN-0535	JIN-0536
Designation	Slide 1,60 m	Slide 1,20 m
Age group	3-10 years	3-6 years
Dimensions of equipment	(LxWxH in mm) 3228 x 920 x 2458	(LxWxH in mm) 2741 X 868 X 2058
Minimum space requirements	(LxW in mm) 6735 x 4104	(LxW in mm) 6116 x 3883
Total impact area	21,7 m ²	19,2 m ²

SOLO +



PICCOLO Maisonettes

+ Ideas

PICCOLO maisonettes are specially designed for small children from **1 to 5 years old**.

+ Design

Available in 3 themes with their corresponding colour matches (Forensic, Cartoon and Aquatic).

+ Fun

Maisonettes are fabulous play features that promote an exchange of activities between children. In the Maisonette version with a command station or sandpit, they offer original, interactive and creative activities.

+ Technical

- Please refer to the **PICCOLO** technical description on page 28



JPX-0033 Piccolo Maisonette 1 forestic



JPX-0032 Piccolo Maisonette 1 cartoon



JPX-0031 Piccolo Maisonette Sand games

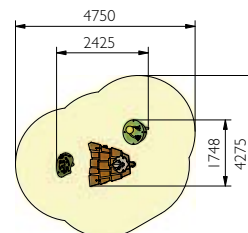
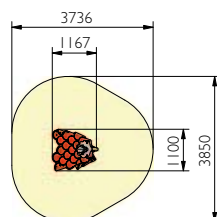
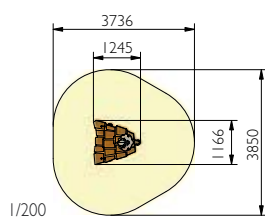

1/200

	JPX-0033	JPX-0032	JPX-0031
Designation	Piccolo Maisonette Forestic	Piccolo Maisonette Cartoon	Piccolo Maisonette Sand Games
Age group	1-5 years	1-5 years	1-5 years
Dimensions of equipment	(LxWxH in mm) 1245 x 1166 x 2250	(LxWxH in mm) 1167 x 1100 x 2250	(LxWxh in mm) 2425 x 1748 x 2250
Minimum space requirements	(LxW in mm) 3736 x 3850	(LxW in mm) 3736 x 3850	(LxW in mm) 4750 x 4275
Total impact area	11,2 m ²	11,3 m ²	11,3 m ²



Play equipment accessible to ALL

SOLO +





Cameleo maisonettes

+ Ideas

Play equipment designed for **2 to 8 year olds**.

+ Design

Available in 5 themes and their corresponding colour matches (Forensic, Fantastic, Cartoon, Aquatic and Historic).

+ Fun

Maisonettes are superb play areas for children to communicate with each other in. Depending on the version, maisonettes can have internal fittings, play panels and hands-on activities.

+ Technical

- Please refer to the CAMELEO technical description on page 62

	JCA-0001	JCA-0004
Designation	Cameleo Maisonette Fantastic	Cameleo Maisonette Cartoon
Age group	2-8 years	2-8 years
Dimensions of equipment	(LxWxH in mm) 1457 x 1336 x 2064	(LxWxH in mm) 1506 x 1448 x 2110
Minimum space requirements	(LxW in mm) 4200 x 4200	(LxW in mm) 4200 x 4200
Total impact area	15,8 m ²	15,8 m ²



Play equipment accessible to ALL

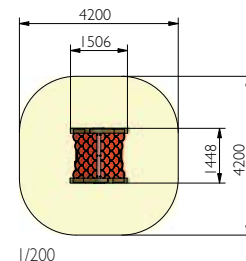
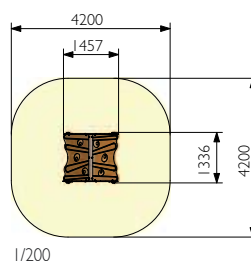

	JCA-0002	JCA-0005
Designation	Cameleo Maisonette Aquatic	Cameleo Maisonette Historic
Age group	2-8 years	2-8 years
Dimensions of equipment	(LxWxH in mm) 2713 x 2614 x 2019	(LxWxH in mm) 1331 x 1912 x 2604
Minimum space requirements	(LxW in mm) 5669 x 5554	(LxW in mm) 4200 x 4851
Total impact area	23 m ²	17,03 m ²



Play equipment accessible to ALL

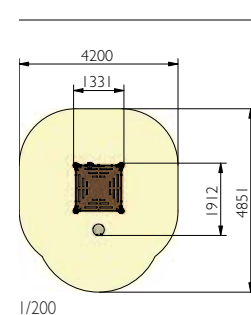
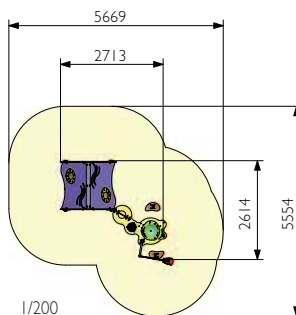



JCA-0001 Cameleo Maisonette Fantastic



JCA-0004 Cameleo Maisonette Cartoon



JCA-0002 Cameleo Maisonette Aquatic



JCA-0005 Cameleo Maisonette Historic

+ OTOS

Childrens furniture

+ Ideas

Seats and small tables designed for 1 to 8 year olds

+ Design

Ergonomics with gentle shapes suited for toddlers

+ Fun

For fostering friendliness.

+ Technical

- Frame work in hot-dip galvanized, powder-coated steel
- Flooring in HPL except for references JPI-0322 (HDPE) and JBC-0308 (panels in recycled material).

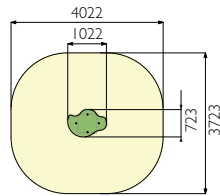
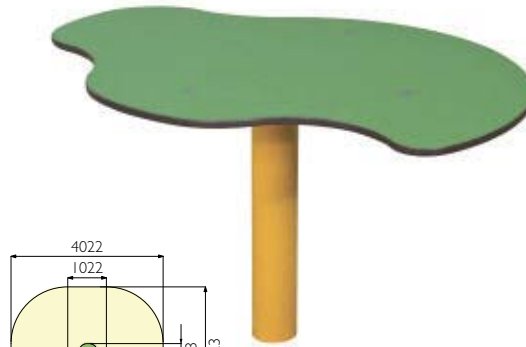

1/200

JPI-0336
Classic Table

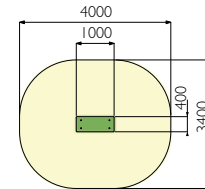
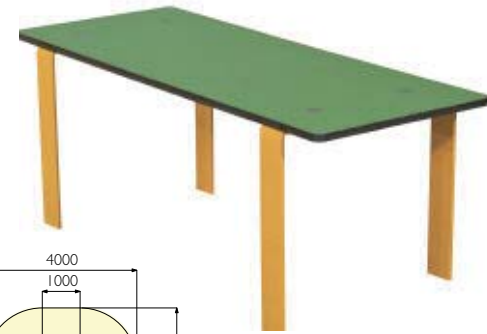

1/200

JJM-1652
Petit Poucet Table

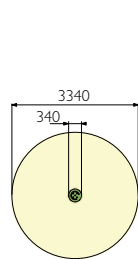

1/200



JPI-0089
HPL Block

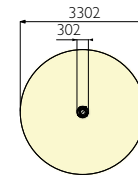

1/200



JPI-0322
HDPE Block

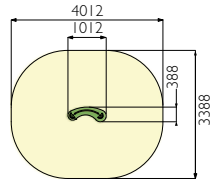
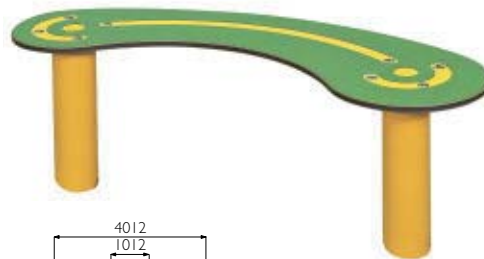

1/200

JPI-0167
Independent Bench

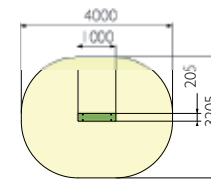

1/200

JJM-1651
Petit Poucet Bench

	JPI-0336	JJM-1652	JPI-0089	JPI-0322
Designation	Classic Table	Petit Poucet Table	HPL Block	HDPE Block
Age group	1-8 years	1-8 years	1-8 years	1-8 years
Dimensions of equipment (LxWxH in mm)	1022 x 723 x 586	1000 x 400 x 415	340 x 340 x 379	302 x 302 x 340
Minimum space requirements (LxW in mm)	4022 x 3723	4000 x 2400	3340 x 3340	3302 x 3302
Total impact area	13,1 m ²	11,7 m ²	8,8 m ²	8,7 m ²



JJM-1650 Cendrillon Bench



JBC-0308 Blanche Neige Bench

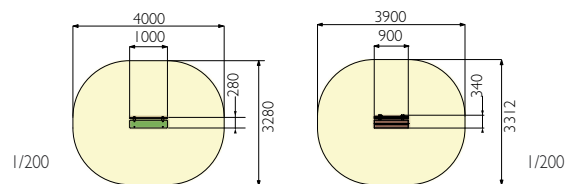

	JPI-0167	JJM-1651	JJM-1650	JBC-0308
Designation	Independent Bench	Petit Poucet Bench	Cendrillon Bench	Blanche Neige Bench
Age group	1-8 years	1-8 years	1-8 years	1-8 years
Dimensions of equipment (LxWxH in mm)	1012 x 388 x 378	1000 x 205 x 220	1000 x 280 x 462	900 x 340 x 498
Minimum space requirements (LxW in mm)	4012 x 3388	4000 x 3205	4000 x 3280	3900 x 3312
Total impact area	11,7 m ²	10,9 m ²	11,2 m ²	11 m ²

SOLO +



Play panels

JJM-1285

Operating station

A small operating station combining several elementary mechanical movements: rotating and reciprocating. The module also offers a little tactile game for recognizing basic shapes.



JJM-0983

Talk-Tube

Or the magic-phone:
Who's on the line?

JJM-1594

3D puzzle

Children align five cylinders correctly for recognizing figurines of sports people.



Sand games

Two formulas for sand games:
The compact module with a sieve and a scoop:
it offers children the possibility of directing sand through filters and down channels manufactured from HPL.
The second larger module also incorporates a sand pit.



JPI-0054

JJM-1282

	JJM-1285	JJM-0983	JJM-1594	JPI-0054	JJM-1282
Designation	Operating station	Talk-Tube	3D puzzle	Big Sand games	Little Sand games
Age group	1-8 years	1-8 years	1-8 years	1-8 years	1-8 years
Dimensions of equipment	(LxWxH in mm) 635 x 436 x 830	12500 (maxi) x 240 x 1325	203 x 203 x 1000	1536 x 1368 x 1067	650 x 668 x 608
Minimum space requirements	(LxW in mm) 3000 x 3000		3203 x 3203	4469 x 4019	3000 x 3000
Total impact area	7,7 m ²		8,1 m ²	13,3 m ²	7,1 m ²



Play equipment accessible to ALL

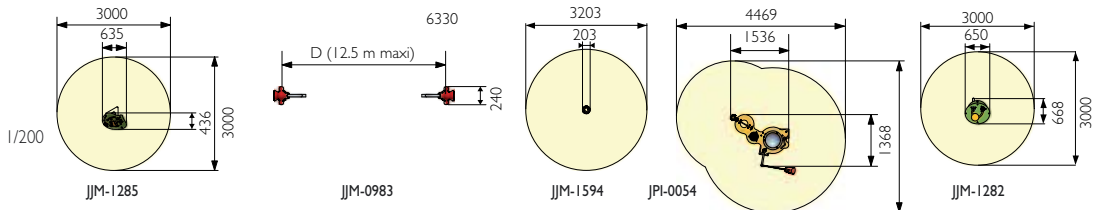

JJM-1660

Theatre

A pocket theatre where, for a few moments, children become actors in the Commedia dell'Arte.



JJM-1661

Tom-Tom

You're really with it, on the beat.



JJM-1662

Driver's cab

A real driver's cab with its "moving landscape". The child turns the wheel and the landscape is displayed on the windscreen. And then suddenly ... bang! An accident. Laughter guaranteed!



Other play panels available: Please refer to technical specifications

7 mistakes

The child is in front of an illustration. He must use his powers of observation to recognize the identical copy of the illustration on one of three others.

JJM-1664

JJM-1663

Masked Knight

"Hi, did you recognize me disguised as the knight in shining armour attacking the blood-thirsty dragon?"



	JJM-1660	JJM-1661	JJM-1662	JJM-1663	JJM-1664
Designation	Theatre	Tom-Tom	Driver's cab	Masked Knight	7 mistakes
Age group	1-8 years	1-8 years	1-8 years	1-8 years	1-8 years
Dimensions of equipment (LxWxH in mm)	1323 x 140 x 1507	1323 x 308 x 1000	1323 x 308 x 1000	1323 x 140 x 956	1323 x 140 x 956
Minimum space requirements (LxW in mm)	4200 x 3000	4200 x 3000	4200 x 3000	4200 x 3000	4200 x 3000
Total impact area	10,7 m ²	10,7 m ²	10,7 m ²	10,7 m ²	10,7 m ²



Play equipment accessible to ALL

1/200

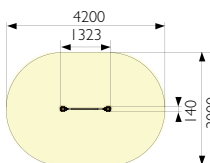

JJM-1660

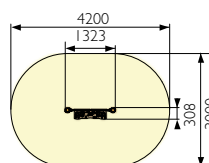

JJM-1661

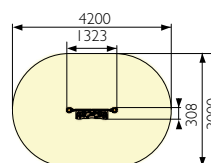

JJM-1662

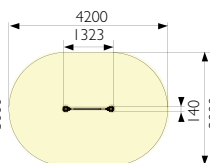

JJM-1663

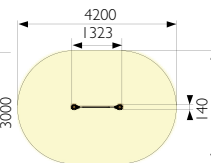

JJM-1664

SOLO +



Concrete table-football tables

+ Ideas

Equipment designed for the **10-17 year-olds**. Exceptionally resistant, they withstand all bad weather conditions.

+ Fun

Table football is extremely popular amongst adolescents

+ Technical

- Concrete surface cast in an aluminium frame
- Reinforced concrete base.
- Solid bars, diameter 16 mm in special high-resistance stainless steel (elastic limit 3 times higher than normal stainless steel)
- Players in powder coated cast aluminium with special vandal-proof fasteners
- The unit is totally independent. It can be moved when required, but it can also be anchored to the ground (ref. JIN-0023)
- Equipment conform to standard NF S 52901 "free access sports equipment"
- For optimal safety, a safety area must be provided around the equipment (as per the plan opposite)

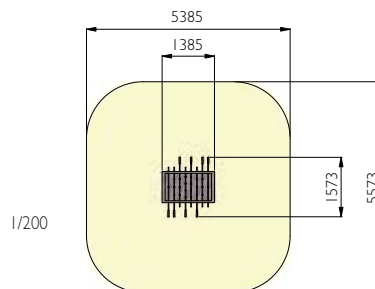
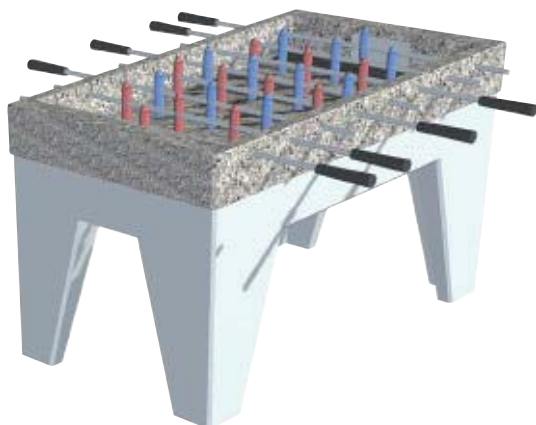



	JIN-0022	JIN-0023
Designation	Table Football (free-standing)	Table Football (to fix)
Age group	10 -17 years	10 -17 years
Dimensions of equipment	(LxWxH in mm) 1385 x 1573 x 860	(LxWxH in mm) 1385 x 1573 x 860
Minimum space requirements	(LxW in mm) 5385 x 5573	(LxW in mm) 5385 x 5573
Total impact area	28,1 m ²	28,1 m ²



Play equipment accessible to ALL

SOLO +



Table-Tennis Tables

+ Ideas

Equipment designed for the **10-17 year olds**.

Exceptionally resistant to bad weather and acts of vandalism.

+ Fun

Open-air table-tennis tables form ideal equipment for encouraging sport and exchanges between adolescents.

HUSSON table-tennis tables have been adopted by thousands of municipalities, sports clubs and leisure centres over the past thirty years...

+ Technical

Stainless steel/HPL model (JIN-0366)

- Preassembled surface in HPL with stainless steel frame and reinforcements and aluminium corner angles
- Net: In stainless steel plate
- Base: In hot-dip galvanized steel tubing
- Fasteners: Vandal-proof stainless steel

Concrete models (JIN-0032 and JIN-0031)

- Reinforced concrete surface cast in an aluminium frame
- Net in thick hot-dip galvanized steel plate
- Reinforced concrete base.
- Equipment conform to standard NF S 52901 "Free access sports equipment"
For optimal safety, a safety area must be provided around the equipment (as per plan opposite)



JIN-0366	
Designation	Ping-Pong Table (stainless/hpl)
Age group	10 -17 years
Dimensions of equipment	(LxWxH in mm) 2730 x 1520 x 893
Minimum space requirements	(LxW in mm) 6730 x 4520
Total impact area	28,5 m ²

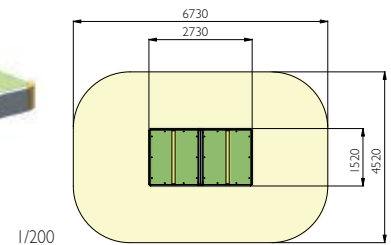

1/200



	JIN-0032	JIN-0031
Designation	Ping-Pong Table (free-standing)	Ping-Pong Table (to fix)
Age group	10 -17 years	10 -17 years
Dimensions of equipment	(LxWxH in mm) 2730 x 1520 x 880	2730 x 1520 x 880
Minimum space requirements	(LxW in mm) 6730 x 4520	6730 x 4520
Total impact area	28,5 m ²	28,5 m ²

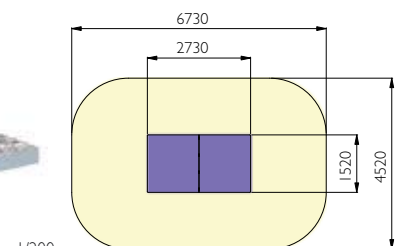
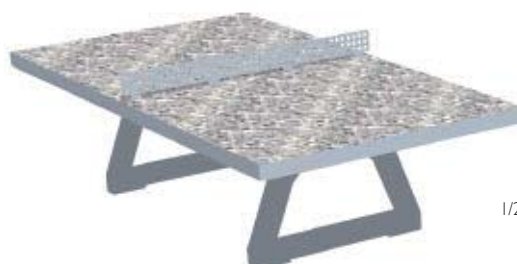

1/200





JIN-0366 Ping-Pong Table (stainless / HPL)



JIN-0032 Concrete Ping-Pong Table

+ OTOS



SOLO+

Gigoto



JVE-0100

Designation	Gigoto
Age group	7-12 years
Dimensions of equipment	(LxWxH in mm) 400 x 350 x 1920
Minimum space requirements	(LxW in mm) 3350 x 3350
Total impact area	8,8 m ²

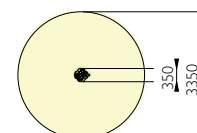

1/200





Skywalker



JVE-0101	
Designation	Skywalker
Age group	7-15 years
Dimensions of equipment	(LxVxH in mm) 1000 x 1000 x 2096
Minimum space requirements	(LxV in mm) 5400 x 5400
Total impact area	23 m ²

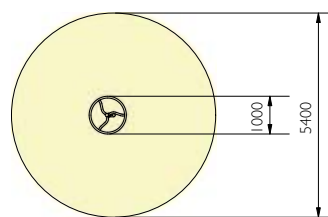

1/200

SOLO +



Skate Training



JVE-0102

Designation	Skate Training
Age group	10-17 years
Dimensions of equipment	(LxVxH in mm) 1886 x 1886 x 1372
Minimum space requirements	(LxW in mm) 5800 x 5800
Total impact area	26,5 m ²

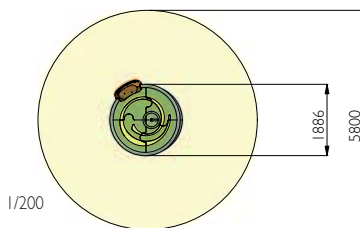



Nitroslide Solo



JVE-0103	
Designation	Nitrogliss Solo
Age group	7-12 years
Dimensions of equipment	(LxVxH in mm) 452 x 3147 x 1844
Minimum space requirements	(LxW in mm) 3852 x 6236
Total impact area	21,6 m ²

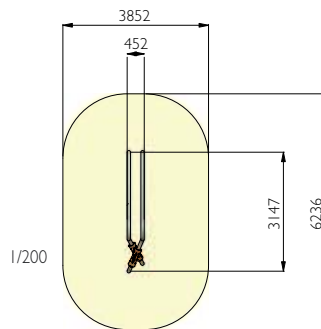

SOLO +





Banzai

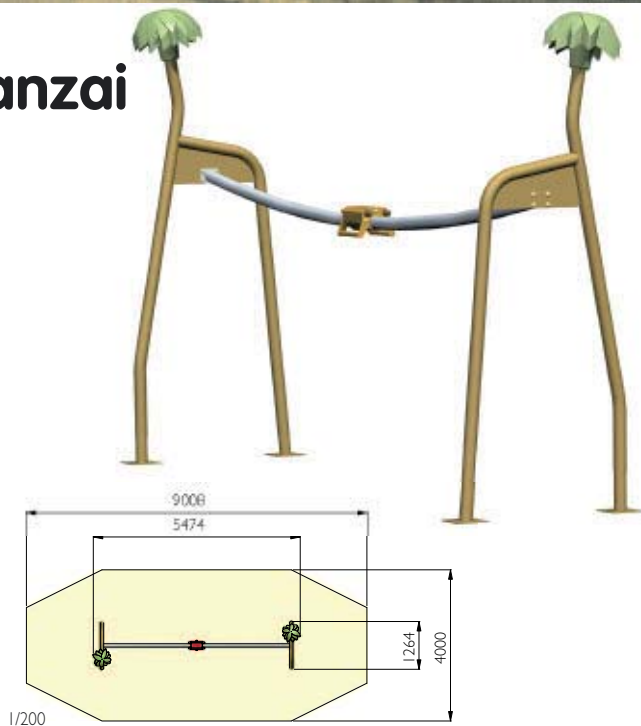

JVE-0104

Designation	Banzai
Age group	7-15 years
Dimensions of equipment	(LxWxH in mm) 5474 x 1264 x 3365
Minimum space requirements	(LxW in mm) 9008 x 4000
Total impact area	32 m ²





Breeze

JVE-0105	
Designation	Breeze
Age group	7-15 years
Dimensions of equipment	(LxVxH in mm) 2004 x 2259 x 1156
Minimum space requirements	(Lxw in mm) 4129 x 4305
Total impact area	13,7 m ²

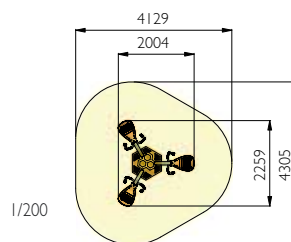

The Dome

+ Ideas

Play equipment designed for **5 to 12 year olds**.

+ Fun

The dome is the ideal multi-activity structure comprising:

- . A number of climbing nets
- . A central access suspension bridge
- . A turboslide

+ Technical

- Structure in hot-dip galvanized, powder-coated steel
- Netting strands with steel cores covered with a thick coat of 3-colour polyamide
- Assembly with the multi-D system (patented) with special vandal-proof stainless steel bolts
- Equipment in compliance with the new European EN 1176 standard, version 2008.



JMA-0732	
Designation	The Dome
Age group	5-12 years
Dimensions of equipment	(LxVxH in mm) 4989 x 5361 x 2532
Minimum space requirements	(LxV in mm) 7900 x 8644
Total impact area	55,1 m ²

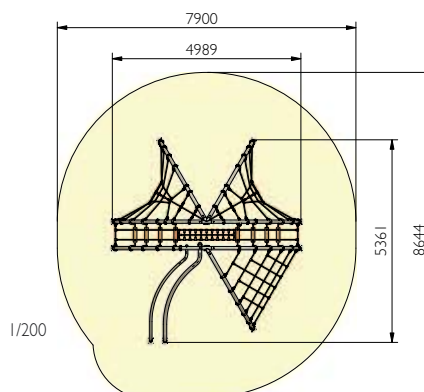



JMA732



www.husson.eu

+ OTOS

207

The 4 m Pyramid

+ Ideas

Play equipment designed for 4 to 10 year olds.

+ Fun

Attractively designed, the small pyramid invites small children to climb and rise to their first challenges in complete safety.

+ Technical

- Upright in hot-dip galvanized steel
- Netting strands with steel cores covered with a thick coat of 3-colour polyamide
- Exclusive net-tensioning system from the central upright providing ideal tension on the ropes and facilitating installation and maintenance
- A practical system for connecting the ropes to each other, for easy and economical servicing (changing a worn rope for example...)
- Equipment in compliance with the new European EN 1176 standard, version 2008.

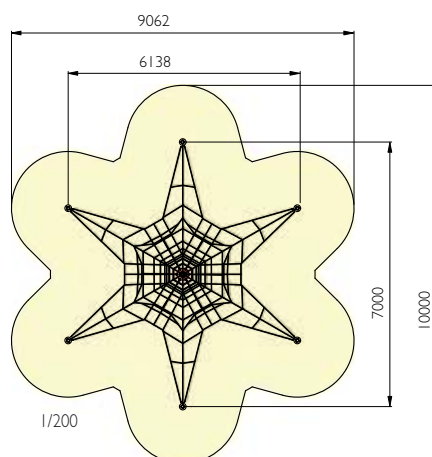



JIN-0511

Designation	The Pyramid of Cord 4 m
Age group	4 -10 years
Dimensions of equipment	(LxWxH in mm) 6138 x 7000 x 4200
Minimum space requirements	(LxW in mm) 9062 x 10000
Total impact area	62,3 m ²

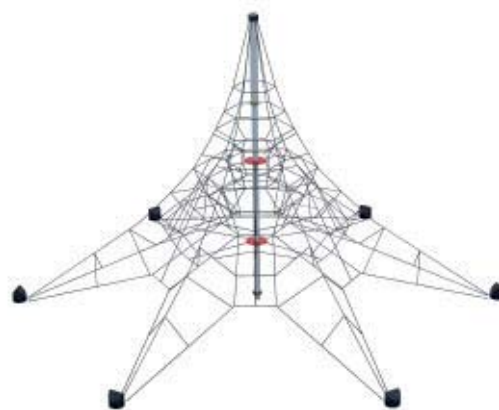

SOLO +



The 6 m Pyramid

+ Ideas

Play equipment designed for **5 to 12 year olds**.

+ Fun

With the HUSSON pyramid, children love getting to the very top in complete safety.

+ Technical

- Upright in hot-dip galvanized steel
- Netting strands with steel cores covered with a thick coat of 3-colour polyamide
- Exclusive net-tensioning system from the central upright providing ideal tension on the ropes and facilitating installation and maintenance
- A practical system for connecting the ropes to each other, for easy and economical servicing (changing a worn rope for example...)
- Equipment in compliance with the new European EN 1176 standard, version 2008.



JIN-0509

Designation	The 6m Pyramid
Age group	5 -12 years
Dimensions of equipment	(LxWxH in mm) 8910 x 10250 x 6200
Minimum space requirements	(LxW in mm) 11660 x 13000
Total impact area	97,1 m ²

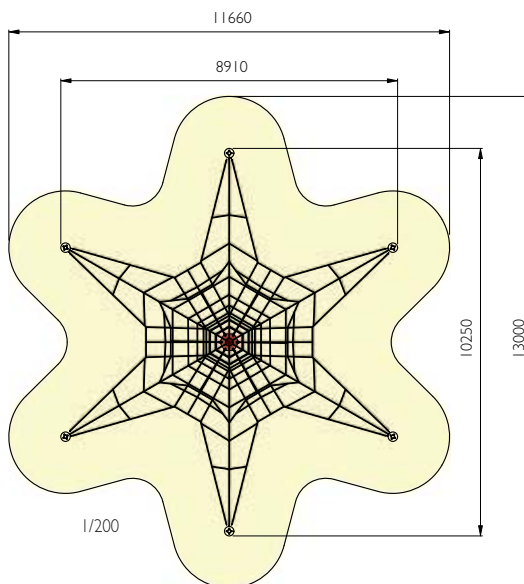

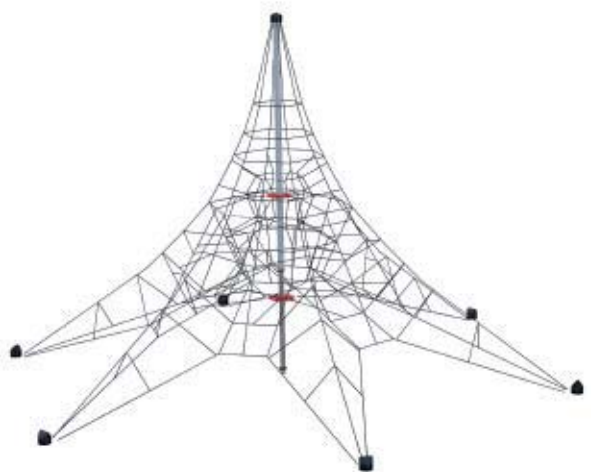
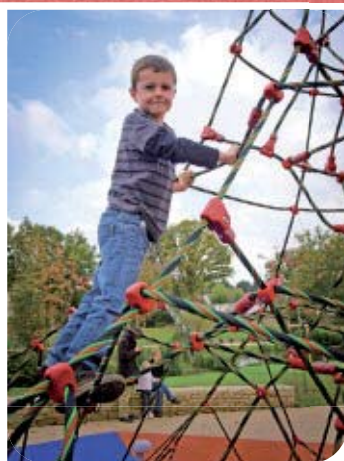

SOLO +



The Telerally 1

+ Ideas

Play equipment designed for the **5 to 14 year olds**. Powered by gravity, the suspended seat travels steadily down the inclined closed circuit rail. This remarkably successful design concept evolved over many years of study and experimentation, in which safety was always the first priority. For maximum durability and ease of maintenance the main rail and immediate supporting structure are manufactured from stainless steel.

+ Fun

Telerally is a brilliant exclusive* game, ideal for amusement parks and leisure centres ...

What could be more fun for children of 5 upwards?

Riding a suspended seat attached to the rail, they are off on a round trip, swinging to and fro in the bends until they reach the end of the ride where they come to a gentle stop.

+ Technical

- Uprights: in hot-dip galvanized power-coated steel
- Panels in HPL
- Rail: An exclusive HUSSON system in stainless steel
- An exclusive carriage with 8 wheels and a moulded protective housing
- Delivered with 1 suspended seat
- Equipment in conformity with the new European EN 1176 standard, version 2008.

*patented systems, registered designs





JTE-0028

Designation	The Telerally I
Age group	5 -14 years
Dimensions of equipment	(LxWxH in mm) 14000 x 9200 x 5500
Minimum space requirements	(LxW in mm) 14000 x 9200
Total impact area	110 m ²

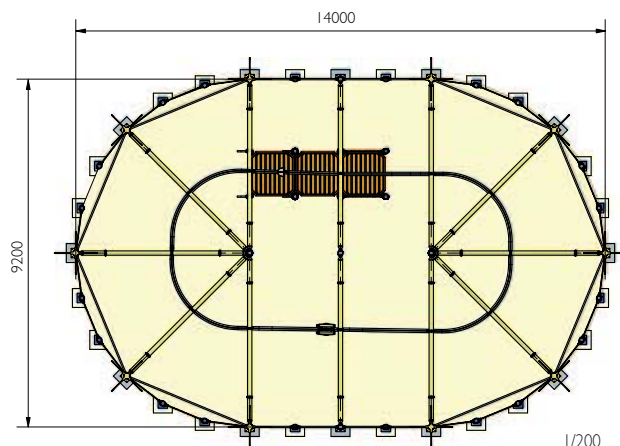

SOLO +



The Telerally 2 large model

+ Ideas

Play equipment designed for the **5 to 14 year olds**.

Powered by gravity, the suspended seat travels steadily down the inclined closed circuit rail. This remarkably successful design concept evolved over many years of study and experimentation, in which safety was always the first priority. For maximum durability and ease of maintenance the main rail and immediate supporting structure are manufactured from stainless steel.

+ Fun

Telerally is a brilliant exclusive* game, ideal for amusement parks and leisure centres...

What could be more fun for children of 5 upwards?

Riding a suspended seat attached to the rail, they are off on a round trip, swinging to and fro in the bends until they reach the end of the ride where they come to a gentle stop.

+ Technical

- Uprights: In hot-dip galvanized power-coated steel
- Panels in HPL
- Rail: An exclusive HUSSON system in stainless steel
- An exclusive carriage with 8 wheels and a moulded protective housing
- Delivered with 1 suspended seat
- Equipment in conformity with the new European EN 1176 standard, version 2008.

*patented systems, registered designs



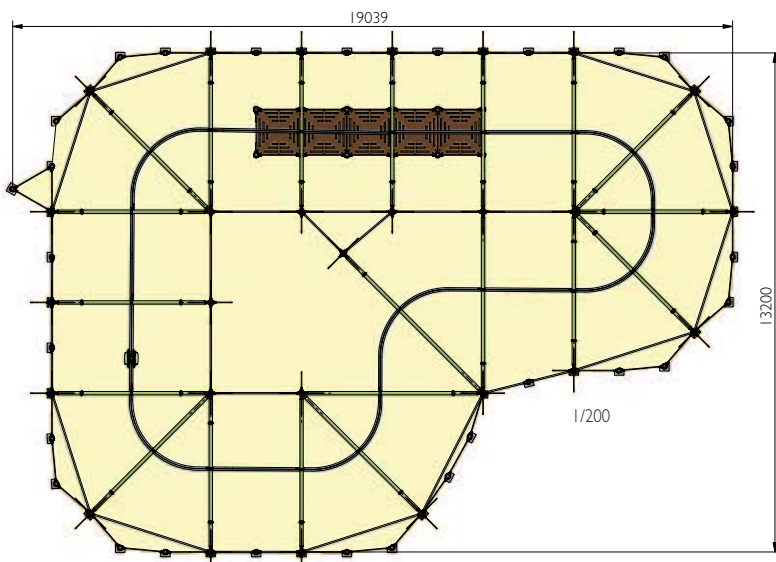

JTE-0029

Designation	The Telerally 2
Age group	5 - 14 years
Dimensions of equipment	(LxWxH in mm) 19039 x 13200 x 5830
Minimum space requirements	(LxW in mm) 19039 x 13200
Total impact area	194,2 m ²

JTE029



www.husson.eu

SOLO +

215

Covered playgrounds

The joys of playing outside
in any weather.

+ Ideas

HUSSON roofing is comprised of a metal framework with a textile cover stretched over it. This system combines every possible advantage: It is translucent, acoustic and self-cleaning. Its ceiling height is usually sufficient for installing multifunctional structures from the **PICCOLO**, **CAMELEO** and **VERTIGO** ranges.

+ Design

A magnificent design with soft rounded shapes for excellent integration into almost any environment.

+ Fun

Most of HUSSON's play equipment has its place under this magnificent shelter.

+ Technical

- Uprights: In hot-dip galvanized power-coated steel
- Aluminium framework
- Stretched textile membrane with special anti-fouling coating
- Complete safety: The whole structure complies with NV65 regulations and resists even the windiest conditions (in zone 3).



365 days a year!



JIN-0544

Designation	Covered playgrounds
Age group	-
Dimensions of equipment	(LxWxH in mm) 17988 x 16532 x 7153
Minimum space requirements	(LxW in mm) 17988 x 16532
Total impact area	-

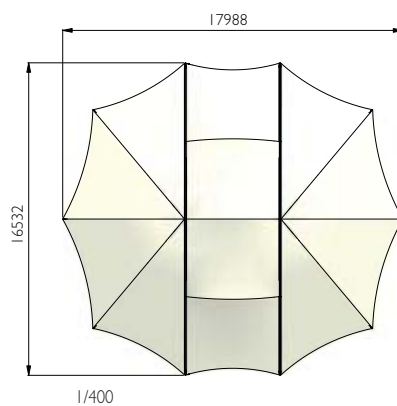

Sandpit and playground kerbs

HUSSON kerbs are ideal for creating attractive sand pits and defining limits to playgrounds.

+ Ideas

Comprised of straight or curved sections for creating sandpits of any shape (square, round, octagonal, etc.) and any size.

HUSSON kerbs are also ideal for setting limits to playgrounds and keeping loose material (sand, gravel or mulch) in place.

+ Technical

- They clip into each other and require no concreting. The weight of the loose material (sand, gravel or mulch) keeps the blocks stable. These blocks are connected together and held in place by means of a galvanized steel pin.
- Made using rotation moulding technology in extra-thick HDPE (High Density Polyethylene) for maximum toughness, this material is colour-through and requires minimal maintenance.
- Granite-sand coloured (other colours available on option).

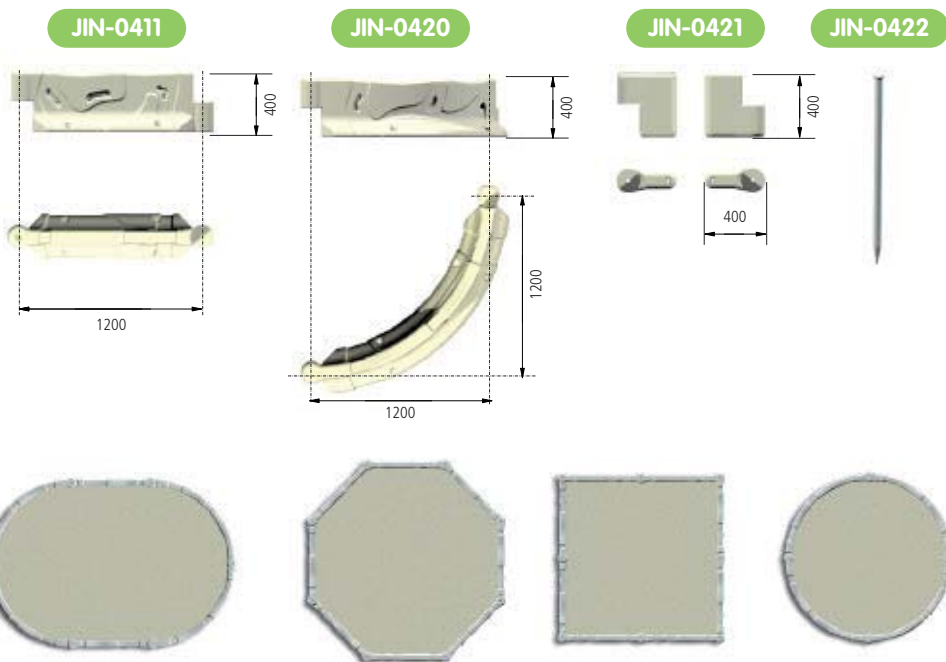

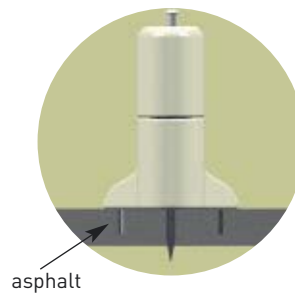
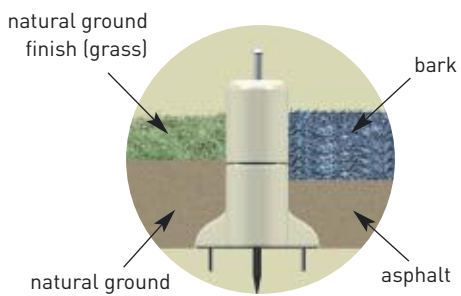

	JIN-0411	JIN-0420	JIN-0421	JIN-0422
Designation	Straight Edging 1200	Curved Edging 1200	Entry Piece for Edging (pair)	Galvanised Nail for Edge fixing
Standard colour	Sand	Sand	Sand	-
Dimensions of equipment	(LxW en mm) 1200 x 400	1200 x 1200 x 400	400 x 400	

+ OTOS



Fencing for playgrounds

The new Luxembourg 2 fencing has been designed to meet a triple requirement: **Safety - functionality - aesthetics.**

+ Ideas

With the HUSSON multidirectional assembly system*, fencing can be used on all types of land and be installed in straight lines or curves, on slopes, etc. The range is completed by two, double or single access gates.

+ Design

Luxembourg 2 fencing has been designed to be incorporated harmoniously into landscapes, public gardens, playgrounds, cycle tracks, condominiums, etc.

+ Safety

To protect children inside a playground, to prevent animals from getting in, for creating outside limits to parks and gardens, etc.

The new Luxembourg 2 fencing has been more especially designed to meet the new European "Playground equipment" standards (EN 1176 -2008), notably for protecting children against any risk of getting their heads or necks caught.

+ Technical

- Arch-shaped post: In hot-galvanized power-coated steel tubing
- Panels
 - Horizontal tubes (Ø 33.7 mm) and solid steel vertical infill bars
 - Double surface treatment: Hot-dip galvanizing and powder-coating
- Several sizes available: lengths 700, 1200 and 1800 mm; heights: 900, 1200 and 1500 mm
- HUSSON multidirectional system* assembly with fastenings in special vandal-proof stainless steel
- Gate available with automatic closing system and anti-noise / anti-trapping system (optional)
- Standard colour: RAL 6005 green

Other colours to RAL specifications (optional)

* Patented system

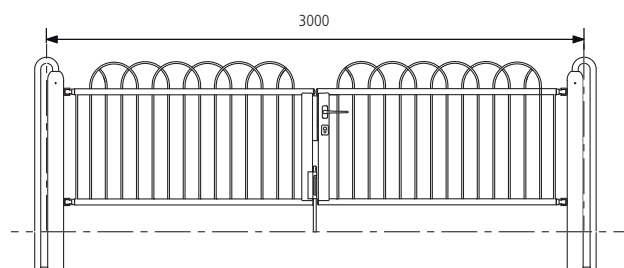

JMU-0299

Designation	"Luxembourg 2" Fence Centre Distance 3000 + Arch
Height (except ground)	Available 3 heights : 900, 1200, 1500 mm
Fixing level	On plate(level 0) or to seal

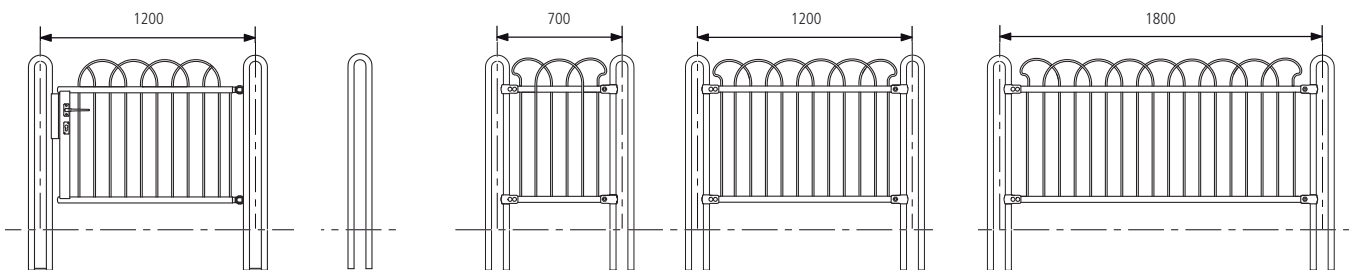

JMU-0298

"Luxembourg 2" Fence Centre
Distance 1200 + Arch

On plate (level 0)
or to seal

JMU-0257

The Arch Post
"Luxembourg 2"

On plate (level 0)
or to seal

JMU-0347

"Luxembourg 2" Fence centre
Distance 700 + Camps

Available 3 heights : 900, 1200, 1500 mm

JMU-0285

"Luxembourg 2" Fence centre
Distance 1200 + Camps

JMU-0288

"Luxembourg 2" Fence centre
Distance 1800 + Camps





Shock-absorbent safety surfaces

For maximal safety and comfort in playgrounds, HUSSON proposes three types of floor covering

Wet pour surface

Their +

- Safety
- Hygienic and easy to maintain
- Excellent durability
- Ease of access for prams and wheelchairs
- A very wide range of colours, decors and play creations
- Smooth surface
- Excellent resistance to outdoor elements.

Prefabricated flexible slabs

In partnership with KRAIBURG, HUSSON proposes a full range of flexible slabs.

Their +

- Safety
- Hygienic and easy to maintain
- Excellent durability
- Ease of access for prams and wheelchairs
- Several colours and decors available
- Very rapid installation at any time of the year.
- Materials that can be 90% recycled

Loose fill

As an alternative to traditional loose aggregate (gravel, rolled pebbles, sand, etc.) HUSSON recommends an ecological, economical and aesthetic solution: mulch!

Their +

- Safety
- Economical solution especially for areas where high falls are possible
- Ecological: Mulch is made by breaking up wood chips
- No splinters, non-dirtying for users
- Several colours available
- Very rapid installation at any time of the year.

These types of safety surfaces comply with the new European EN1177 standard, version 2008 and are put in place by HUSSON approved professionals.

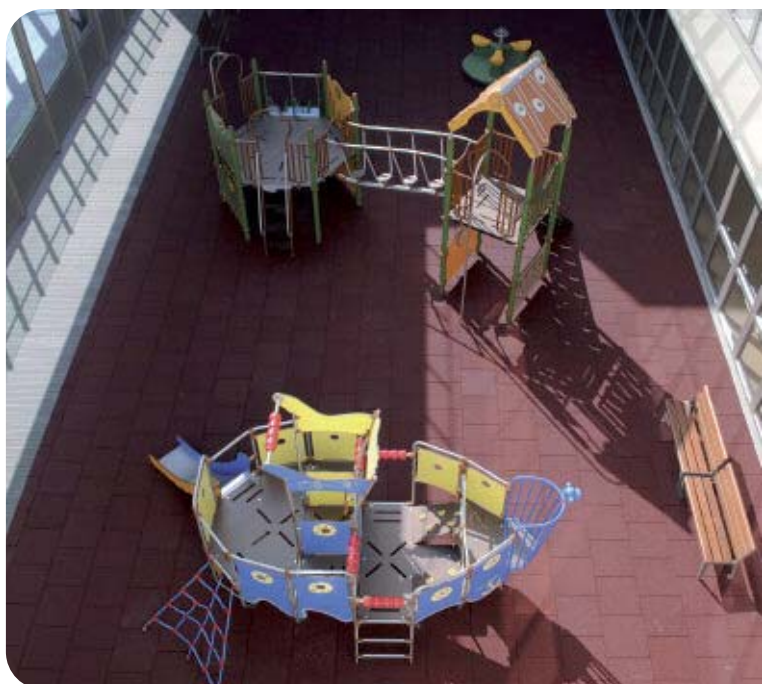



+ OTOS



Playground signposting

General information boards

For giving parents, child minders and children information on the different age categories for which the play equipment present has been designed.

+ Technical

- Board in HPL (high pressure laminate) 15mm thick, extremely tough, colour through, UV-treated material
- Board engraved in high-resistance polycarbonate
- Fixed on an upright \varnothing 89mm, 1180 mm long in painted galvanised steel
- Assembled with powder-coated cast aluminium clamps and stainless steel vandal-proof fasteners

+ Ideas

- Functional, aesthetic and tough
- Easy to install
- Exclusive polycarbonate panel engraving process
- Personalized text (ages, telephone numbers, etc.) available in several languages
- Standard colour: Red HPL and Perspex, Grey Titanium upright and assembly elements

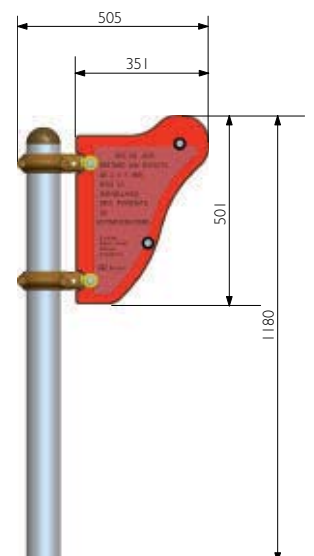
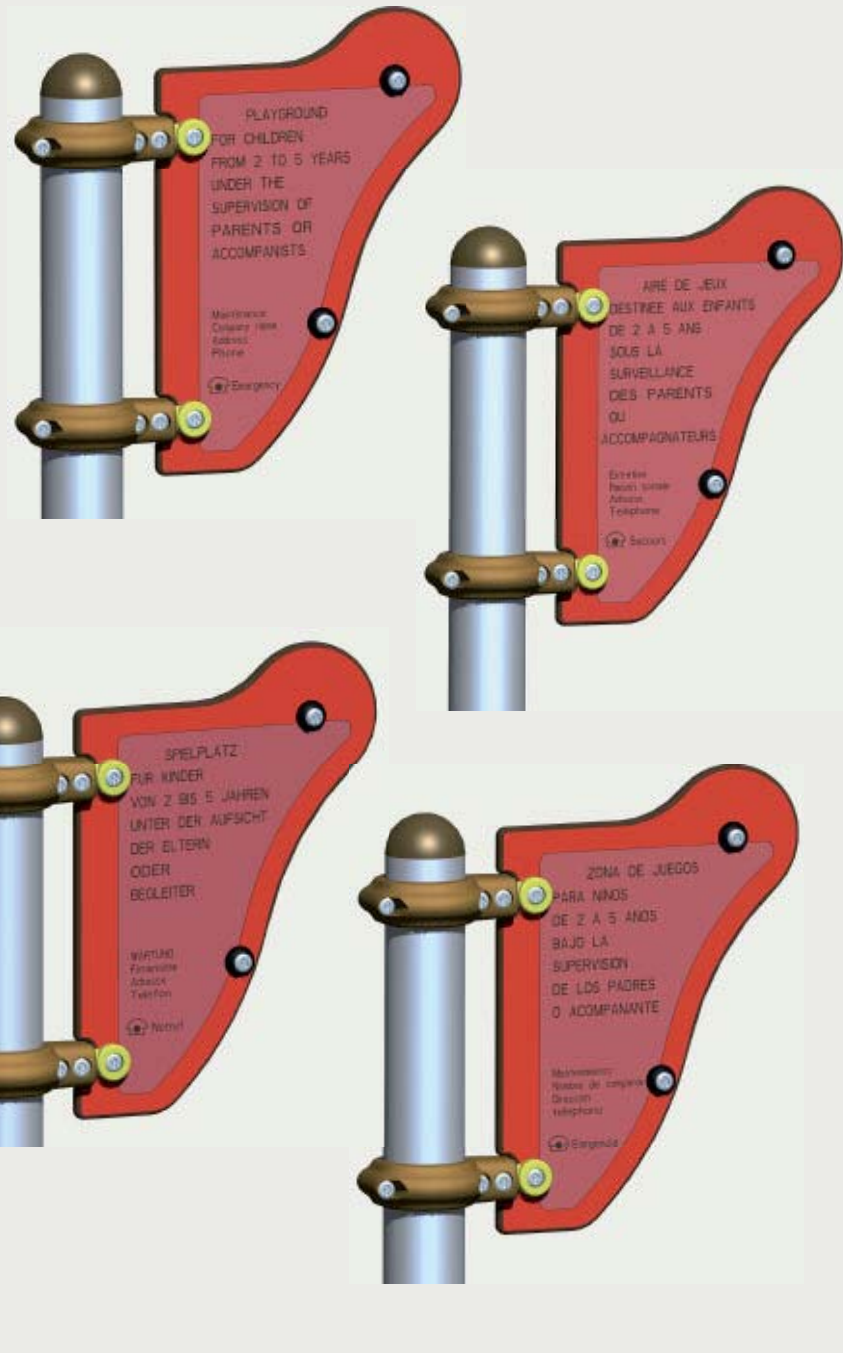

JJM-1656

Designation	The information board fixed on 1 Post
Panel Dimensions	(Wxh en mm) 351 x 501

The themed information board

Thanks to our integrated design department, we can make themed panels to your specifications.

+ Technical

- Board in HPL (high pressure laminate) 15mm thick, extremely tough, colour through, UV-treated material
- Panel in high-resistance polycarbonate, 4-colour printing
- Fixed on an upright Ø 89mm, 2900 mm long in painted galvanised steel
- Assembled with powder-coated cast aluminium clamps and stainless steel vandal-proof fasteners

+ Ideas

- For having an overall view of the playground
- For defining age categories for different play areas
- For informing users of opening times, any special conditions of use, etc.
- For personalizing displays with the logos of possible sponsors, etc.
- For welcoming everyone to your playground!



JMS-J1315-100

Designation	The information board fixed on 2 Posts
Panel Dimensions	(Wxh en mm) 1040 x 878

+ OTOS





See you soon in your new playground ...





HUSSON it's also...

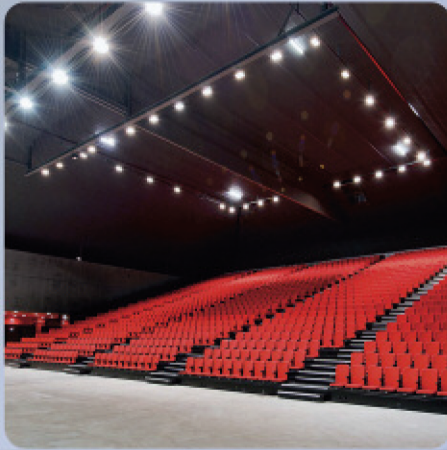

HUSSON International is constantly seeking to improve its products and therefore reserves the right to modify the specification of the models shown without prior notice. Actual products may differ from photos and illustrations.

HUSSON UK

Unit C6, Brunel Gate
 Telford Close - Aylesbury
 Buckinghamshire - HP 19 8 AR
 Tel. 01296 337790
 Fax 01296 33457
www.husson.co.uk
 E.mail : husson@husson.co.uk



**Playgrounds
 & Street Furniture**
www.husson.co.uk

HUSSON International s.a.
Legendary strength

ROUTE DE L'EUROPE
 B. P. N°1 - 68650 LAPOUTROIE- FRANCE
 TEL.: +33 3 89 47 56 56 - FAX : +33 3 89 47 26 03
www.husson.eu - E.mail : husson@husson.eu